

スタンドカラー  
後身頃  
表地 x1  
PATTERN FL

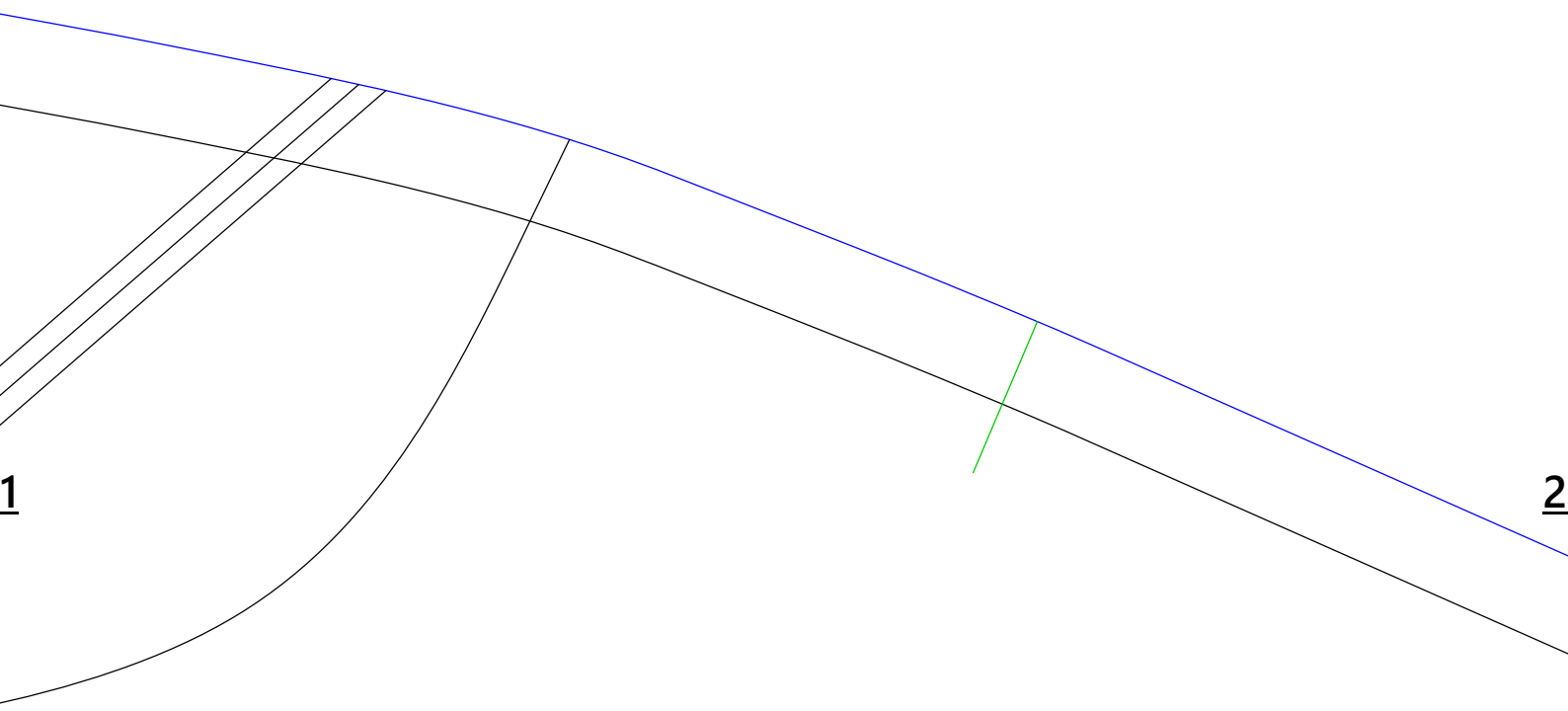

1

2

コート

EEK

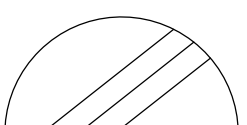

2

2

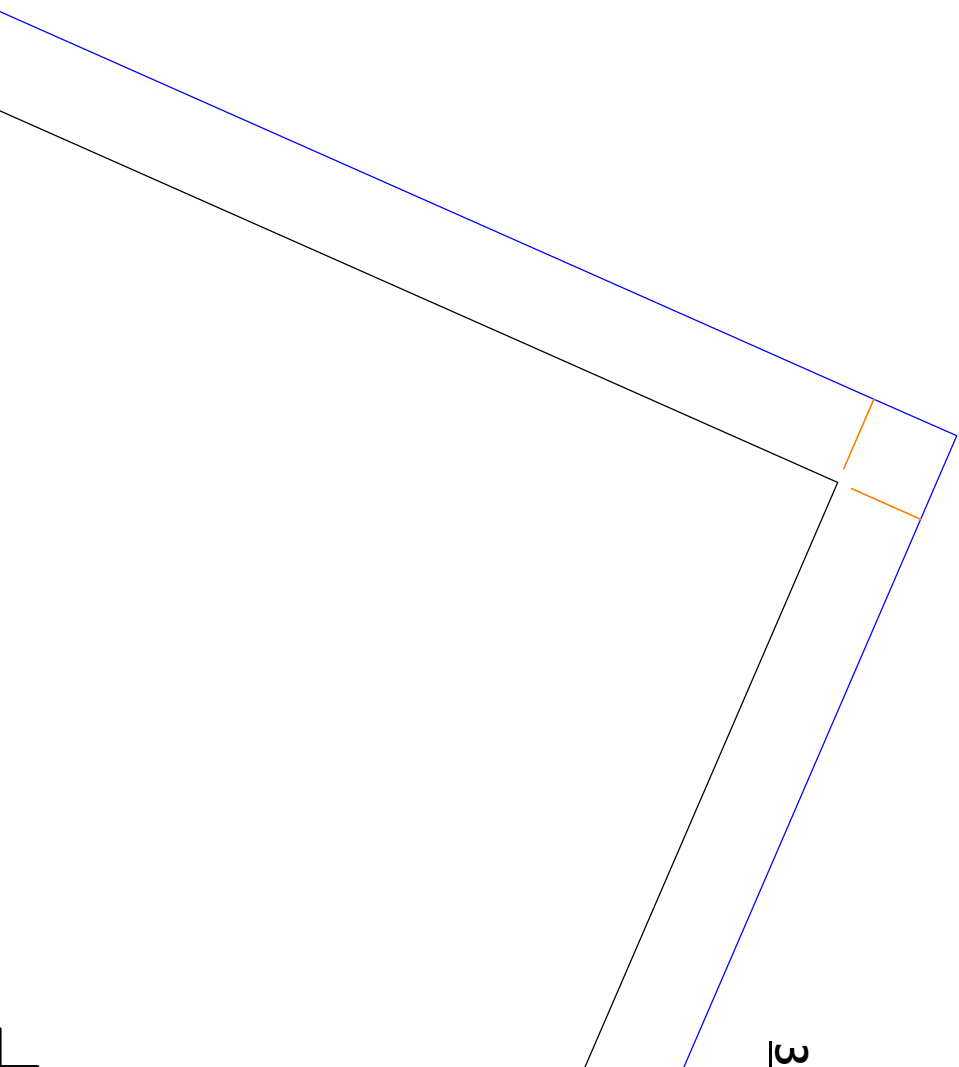

3

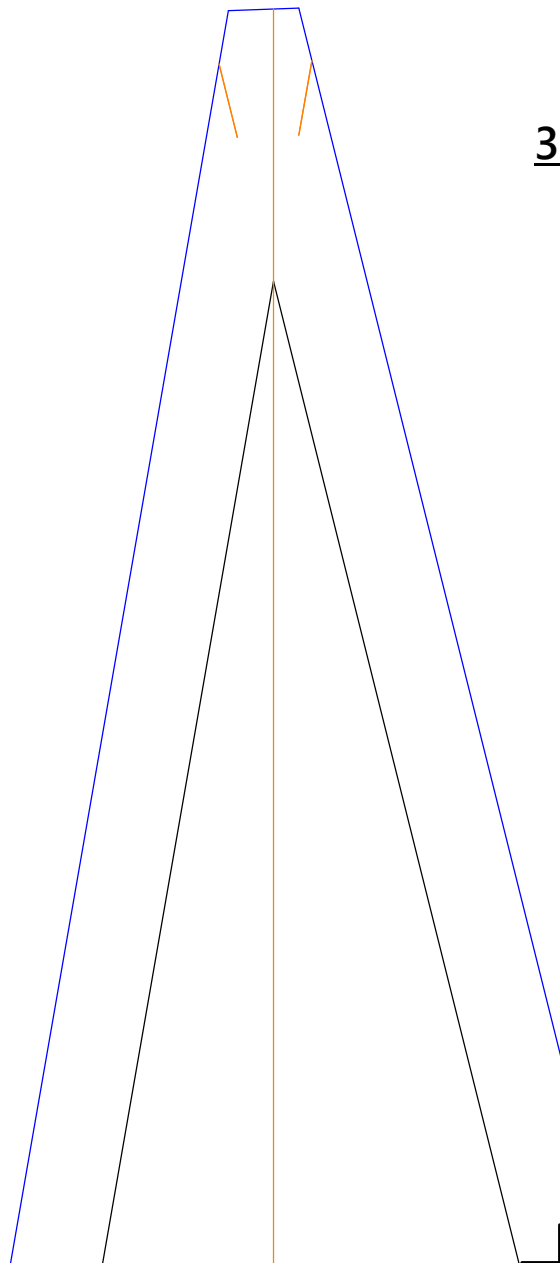

3

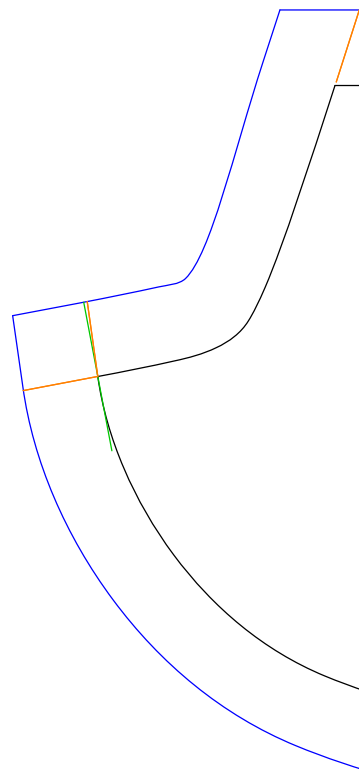

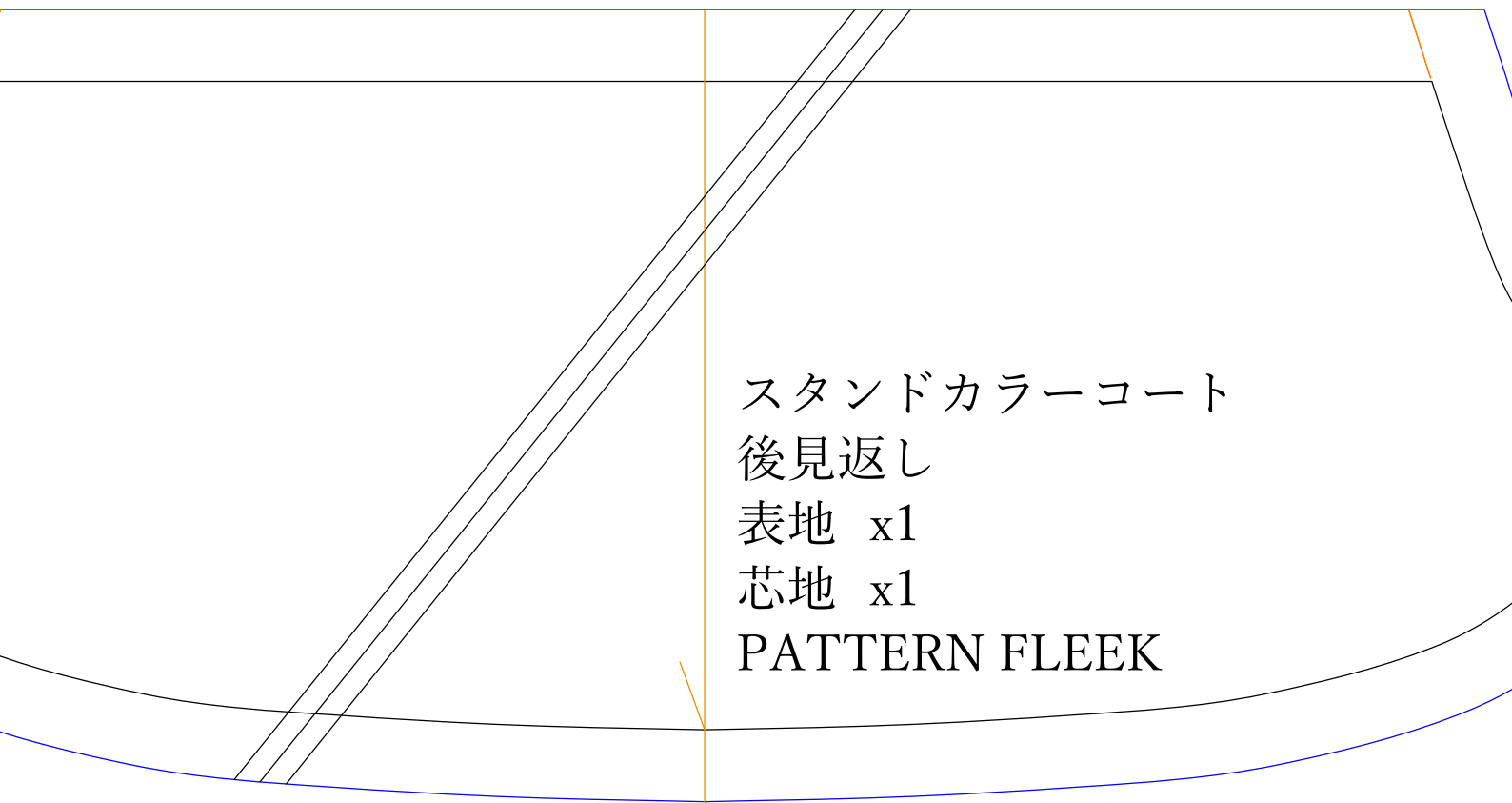

スタンドカラーコート  
後見返し  
表地 x1  
芯地 x1  
PATTERN FLEEK

3

4

4

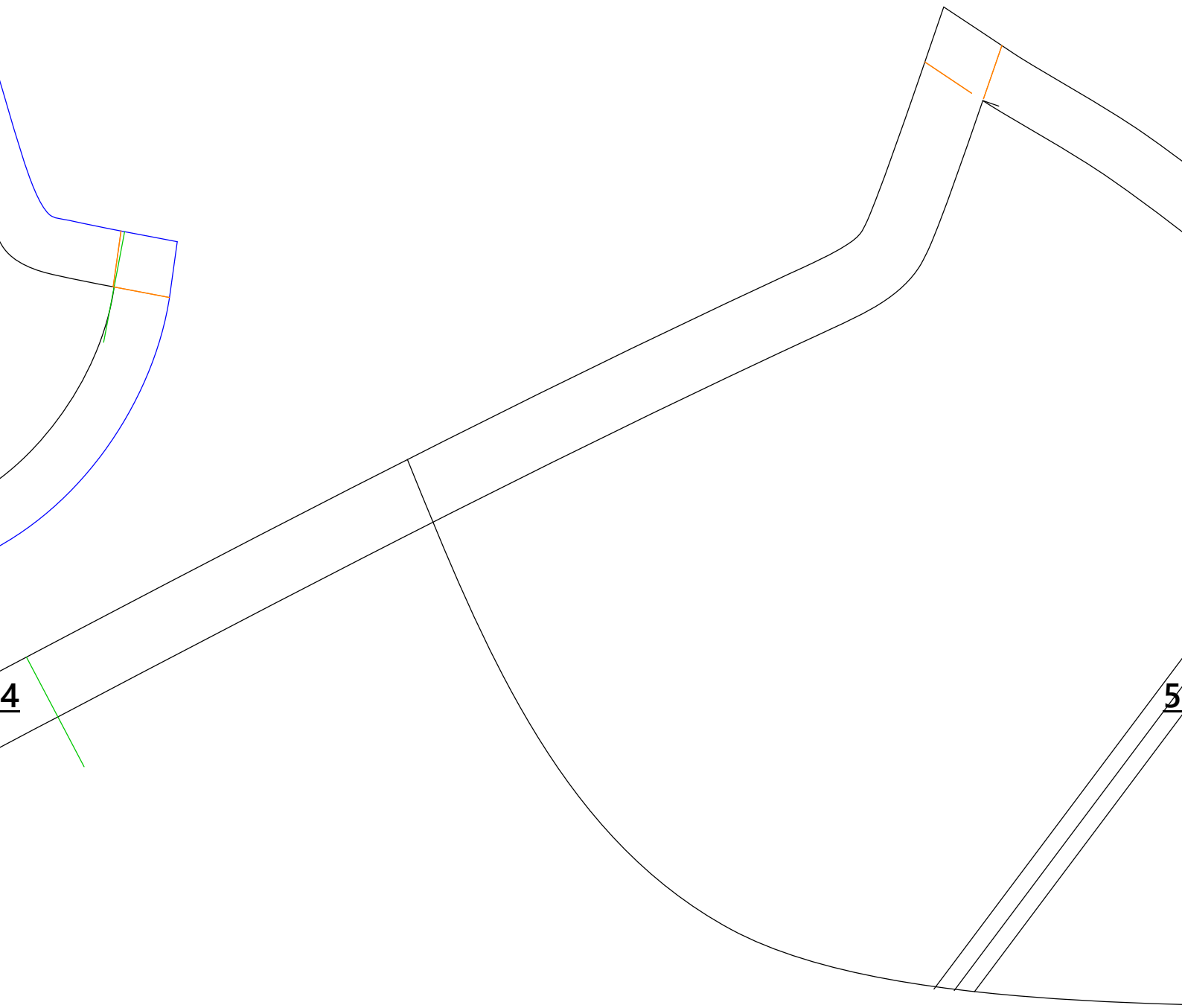

スタンドカラーコ  
前身頃  
表地 x2  
PATTERN FLEECE

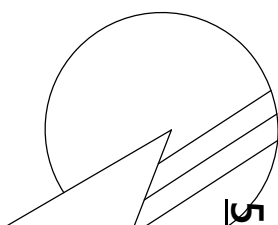

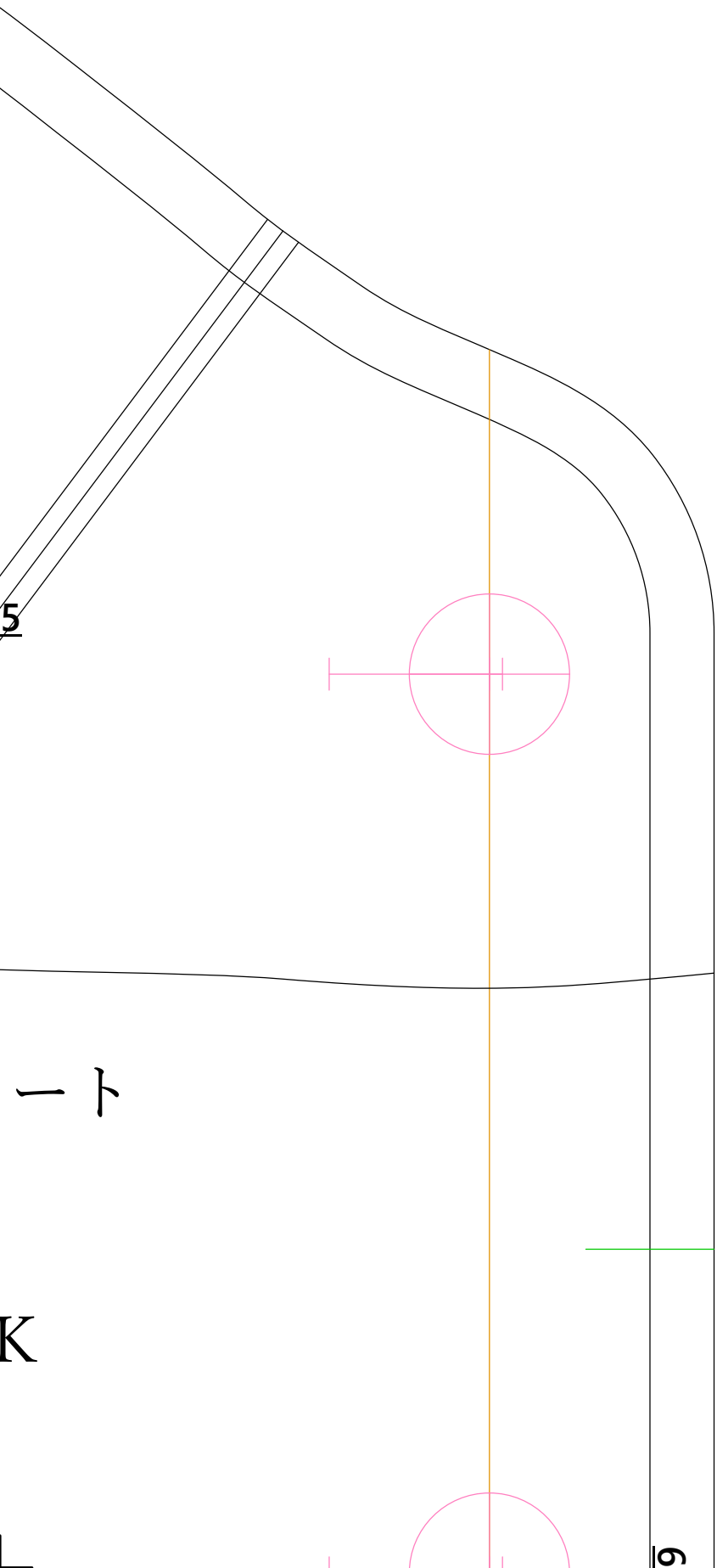

5

ト

K

9

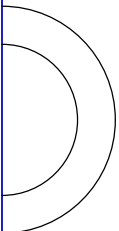

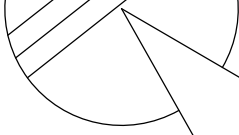

2

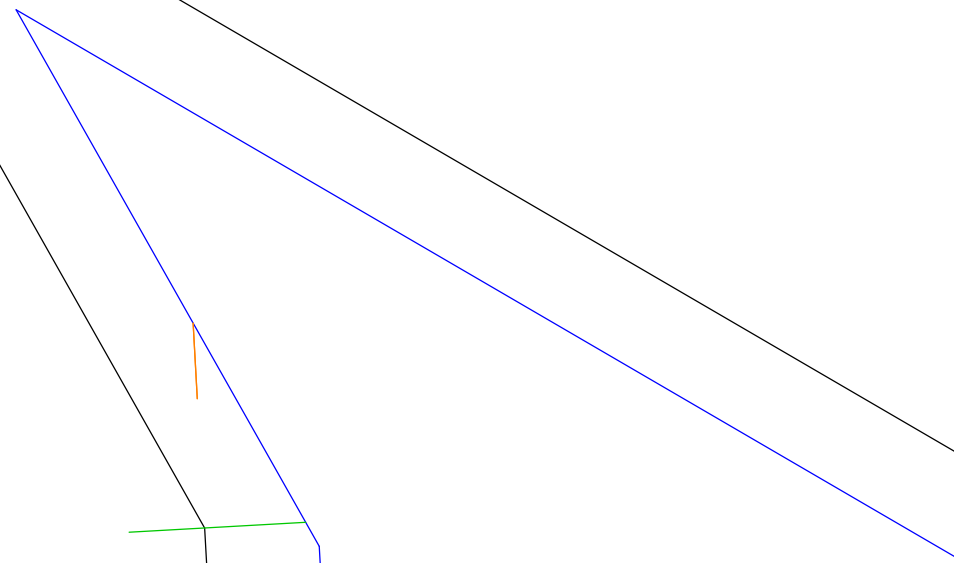

7

8

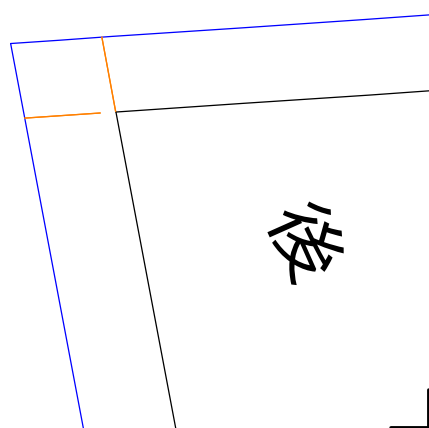

後

8



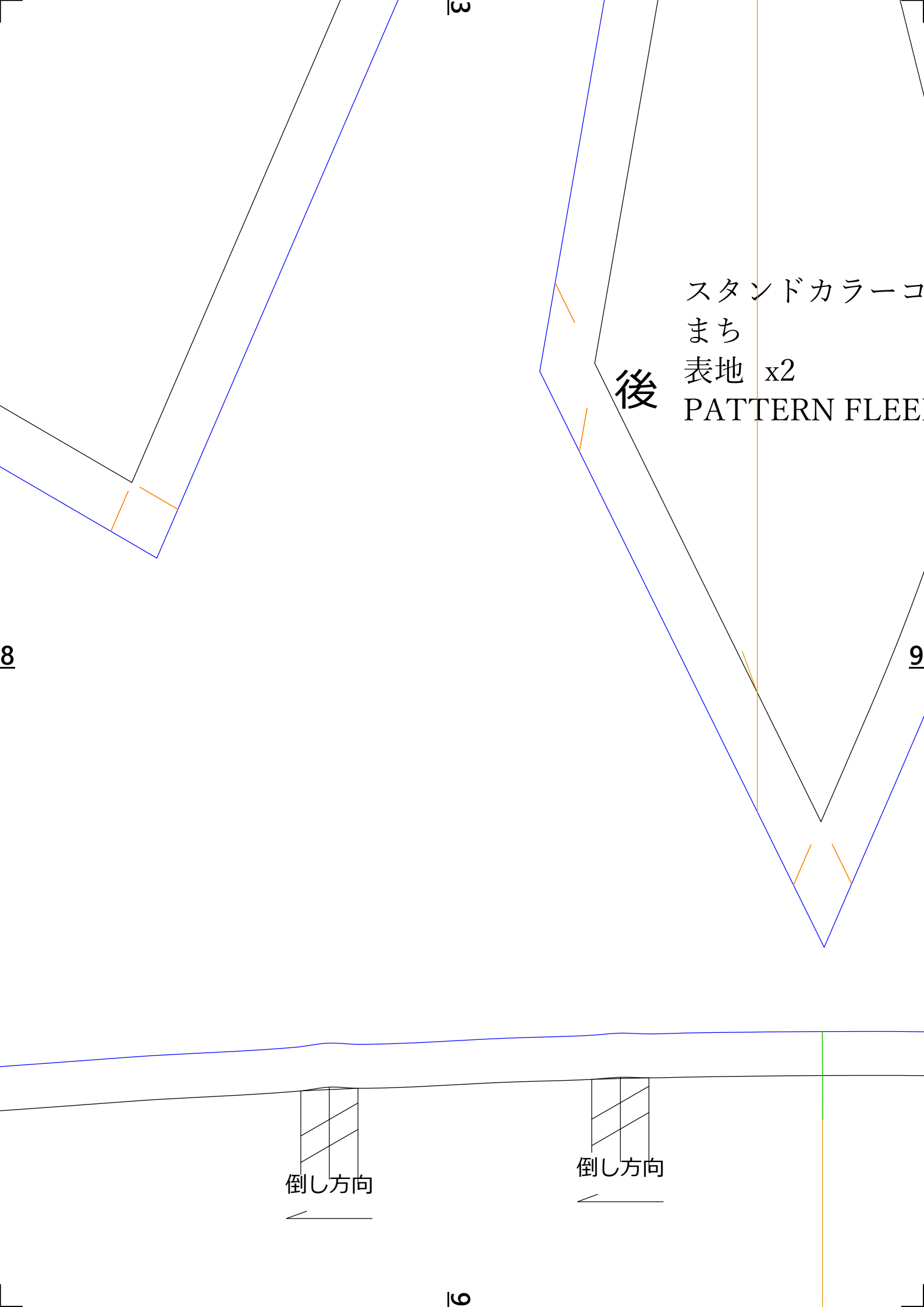

後

スタンドカラーコ  
まち  
表地 x2  
PATTERN FLEECE

倒し方向

倒し方向

8

9

9

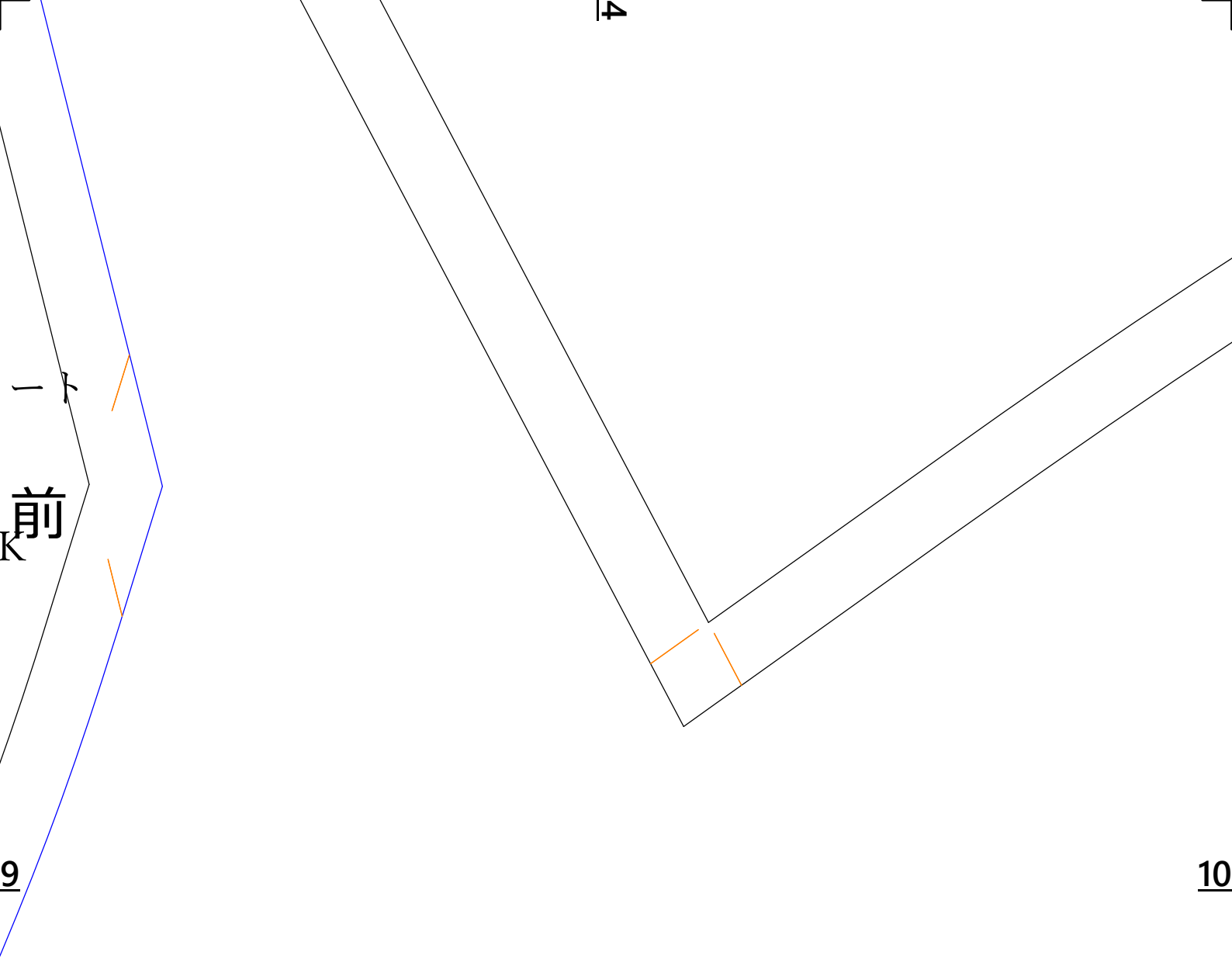

下  
前

9

4

10

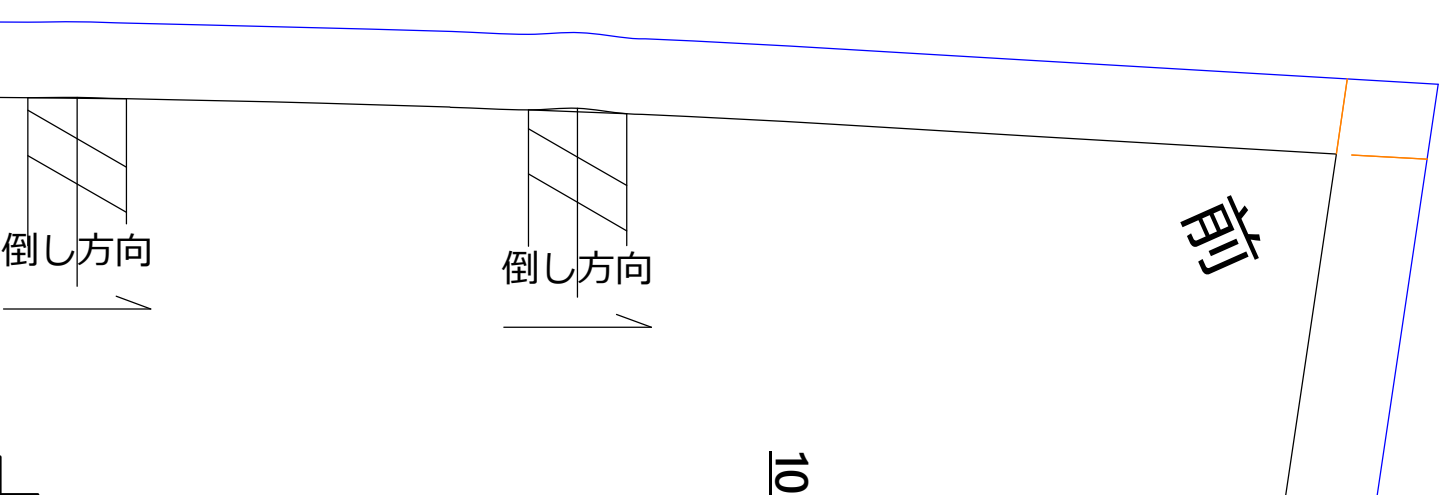

倒し方向

倒し方向

前

10

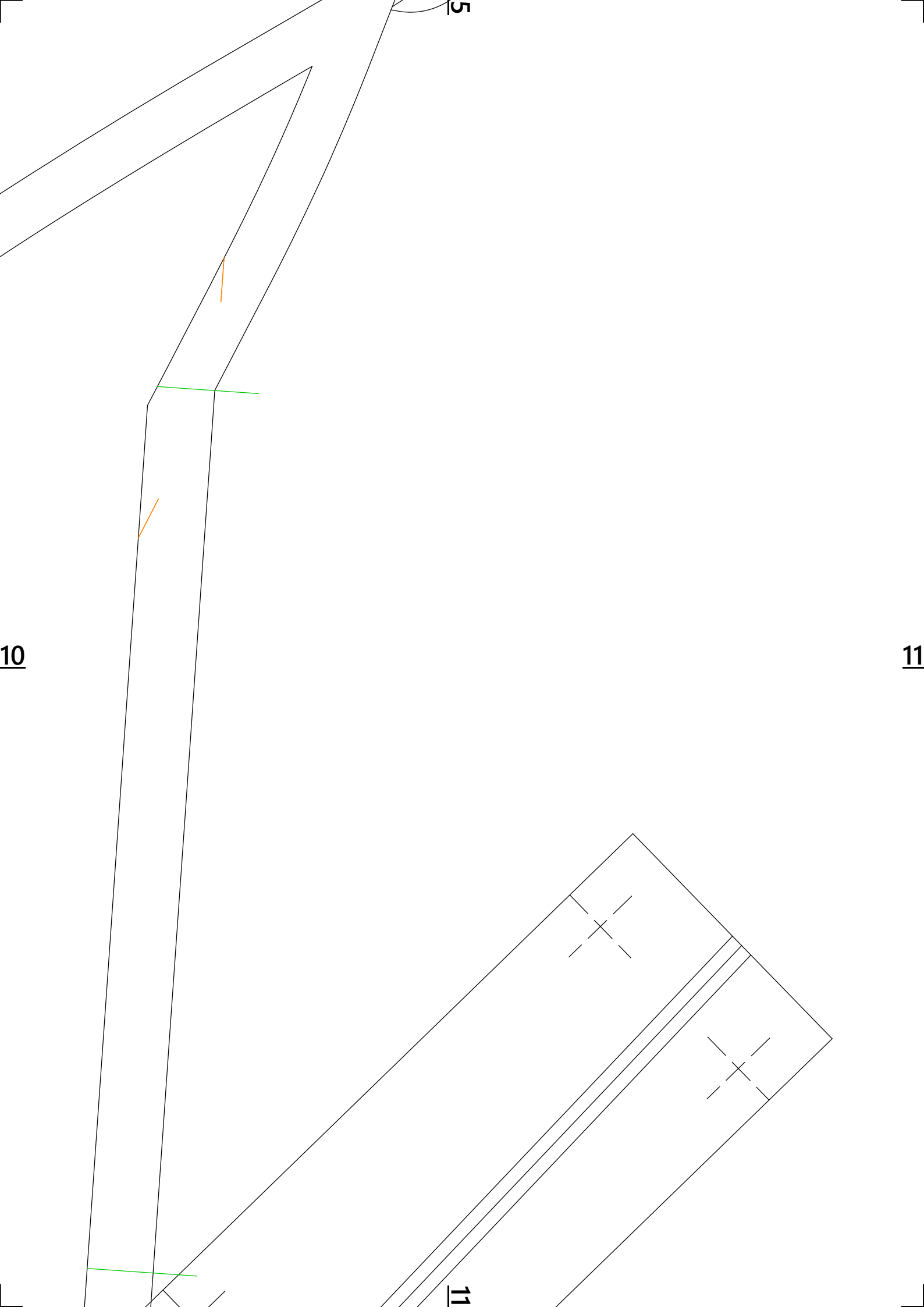

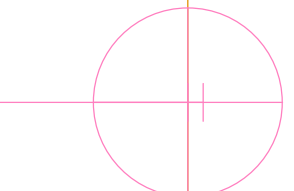
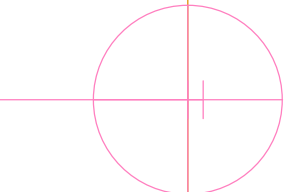
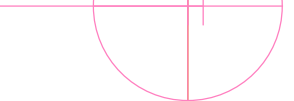

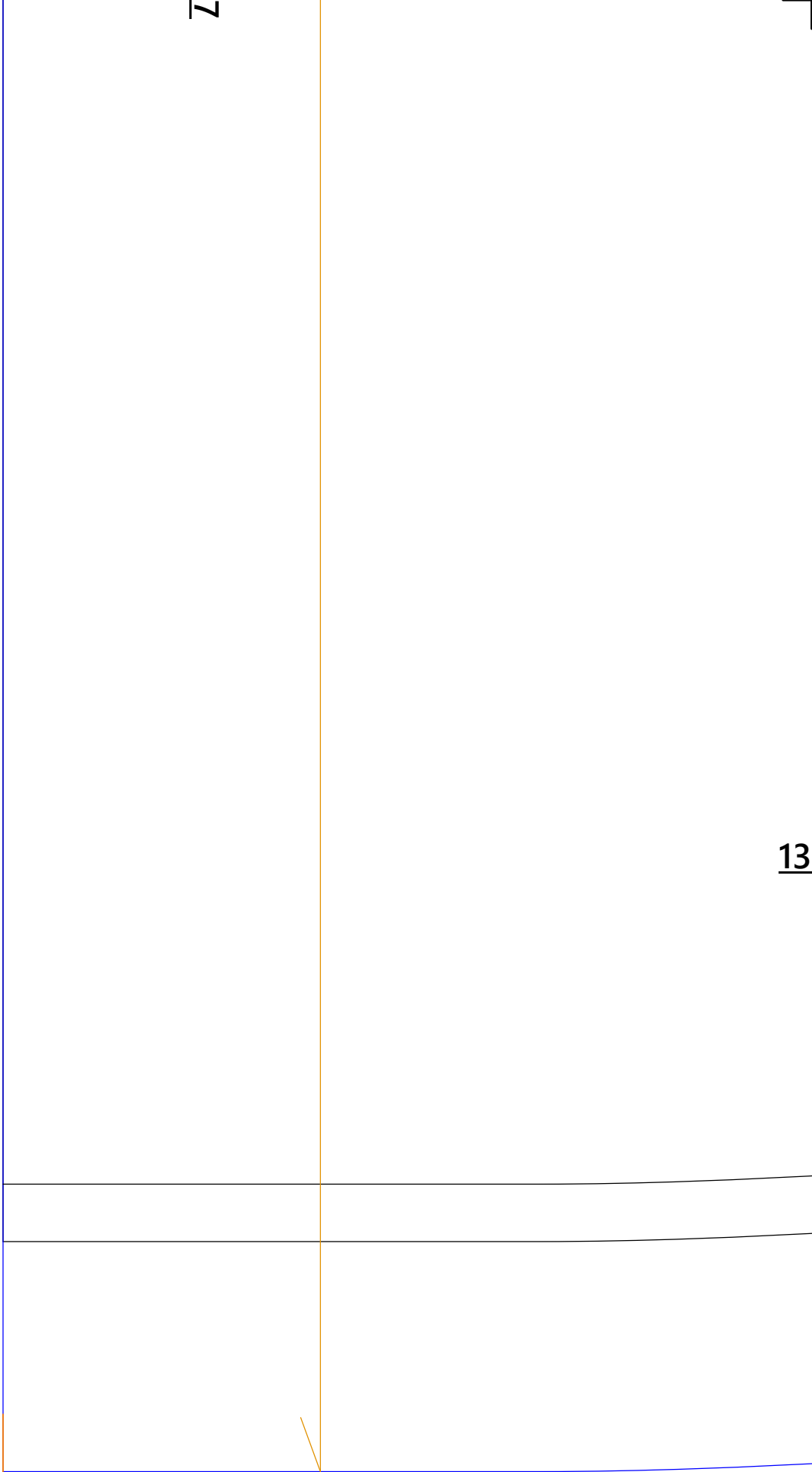

13

8

14

14



スタン  
袖口  
表地 x2  
PATTE

14

15

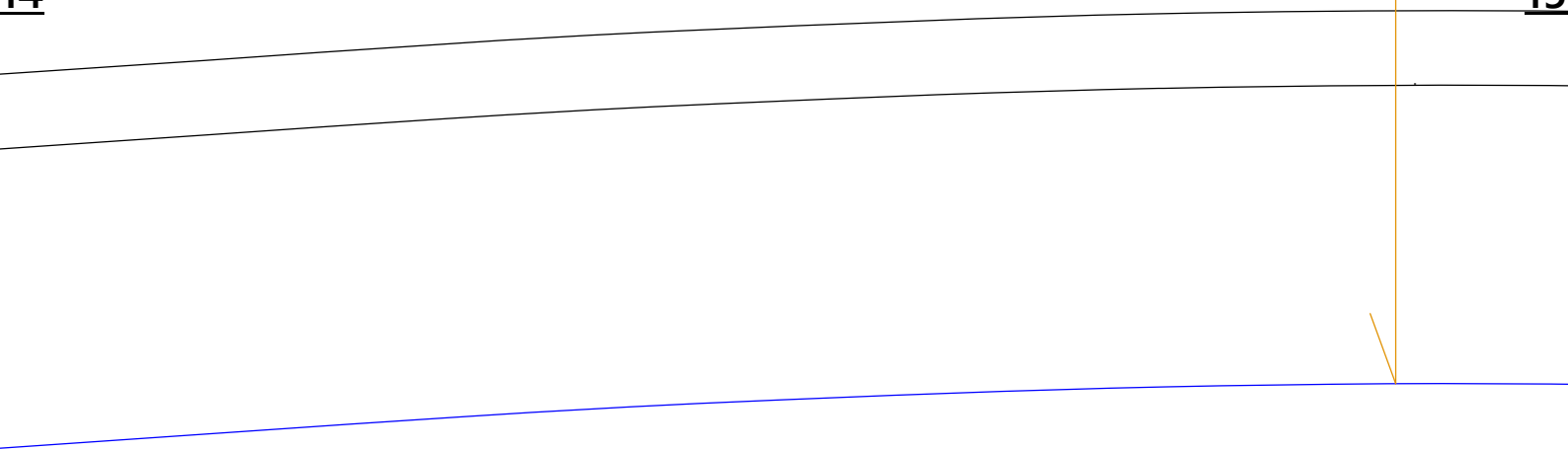

15

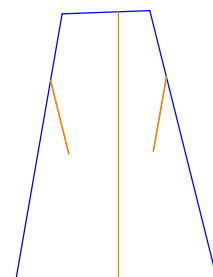

ドカラーコート

2  
ERN FLEEK

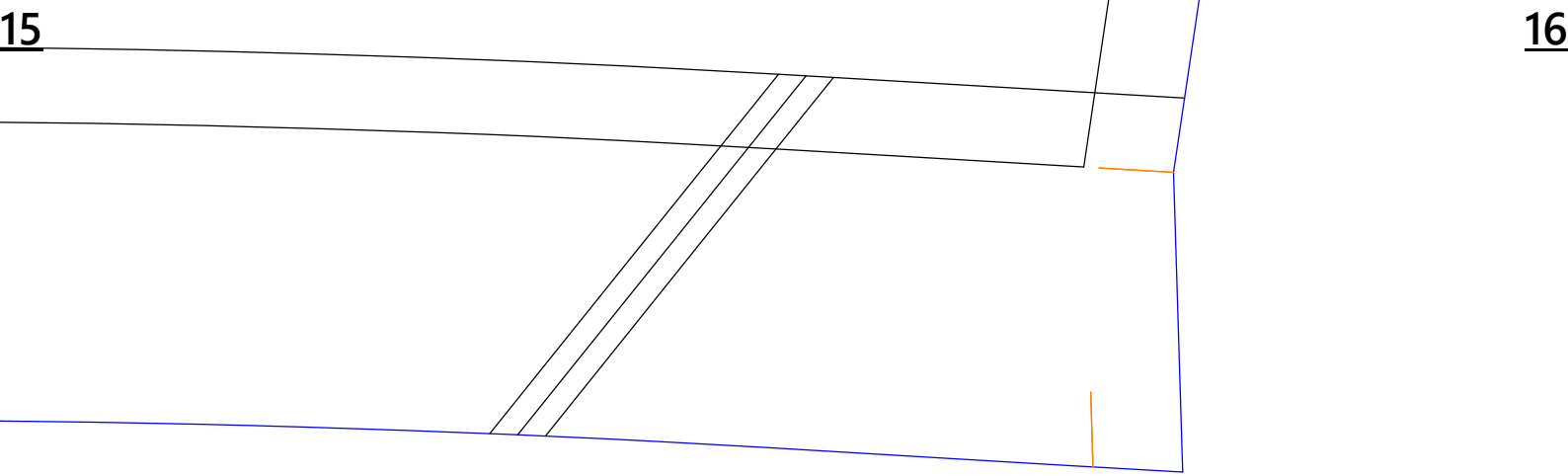



11

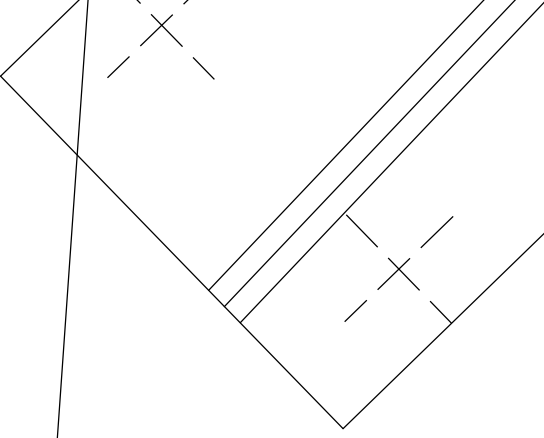

16

17

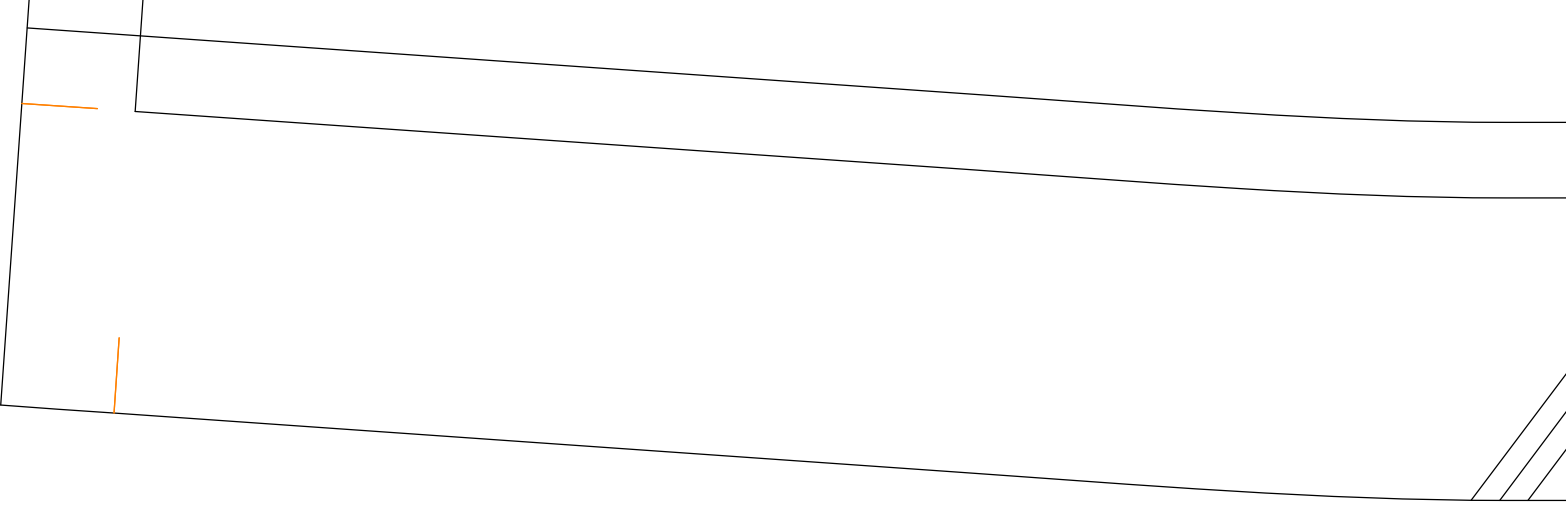

17

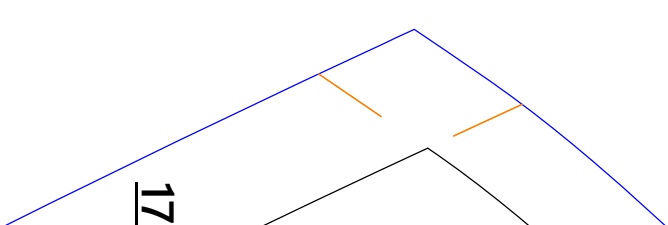

12

17

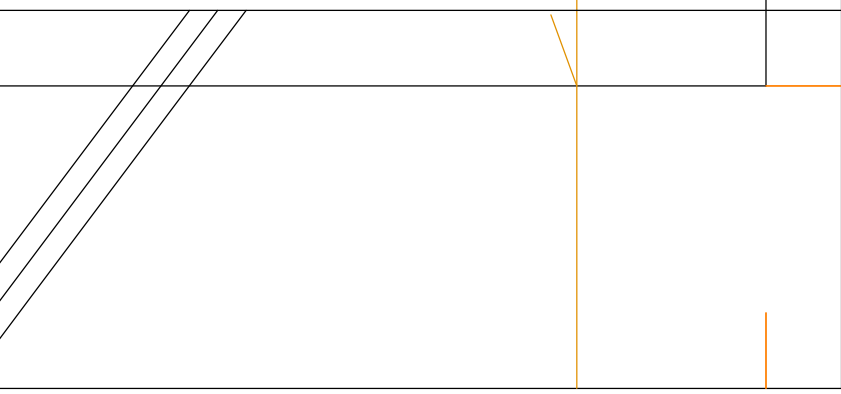

18

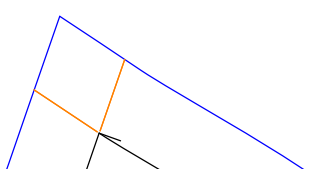

13



19

19

スタンドカラー  
裏後身頃  
裏地 x2  
PATTERN FL

14

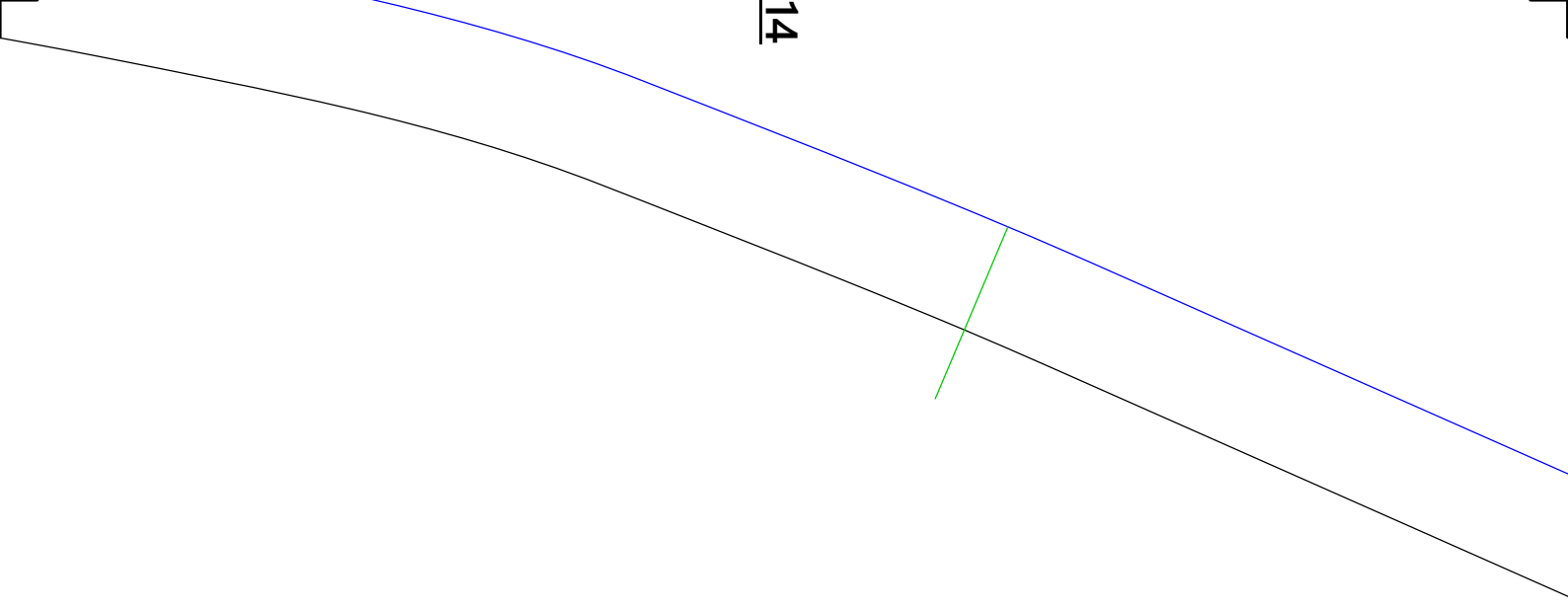

19

コート

20

LEEK

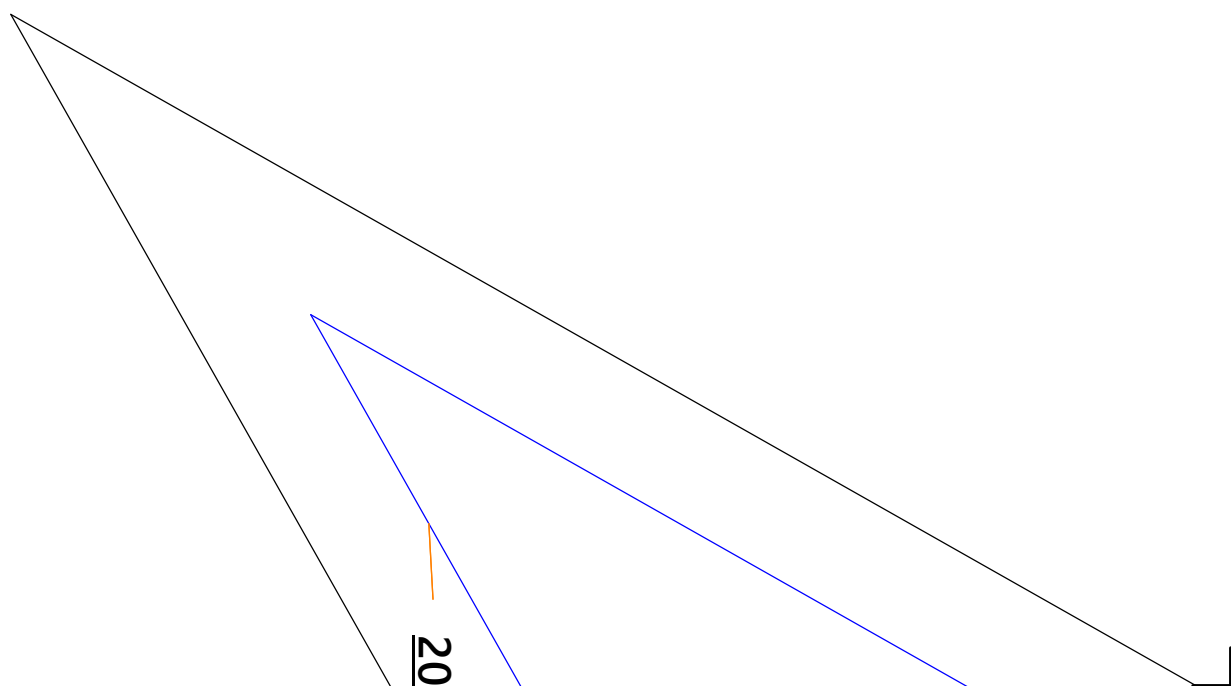

20

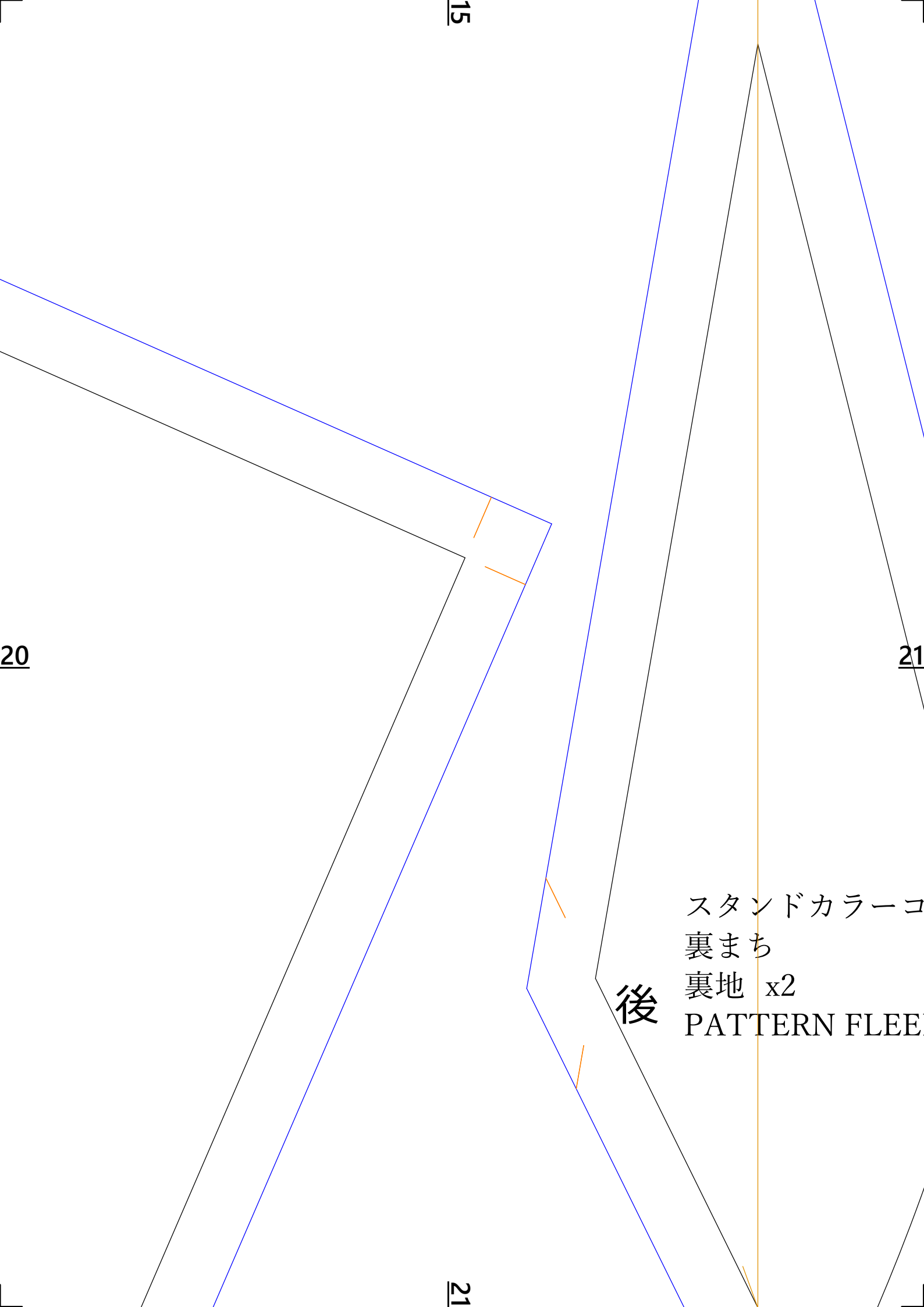

15

20

21

後

スタンドカラー  
裏まち  
裏地 x2  
PATTERN FLEECE

21

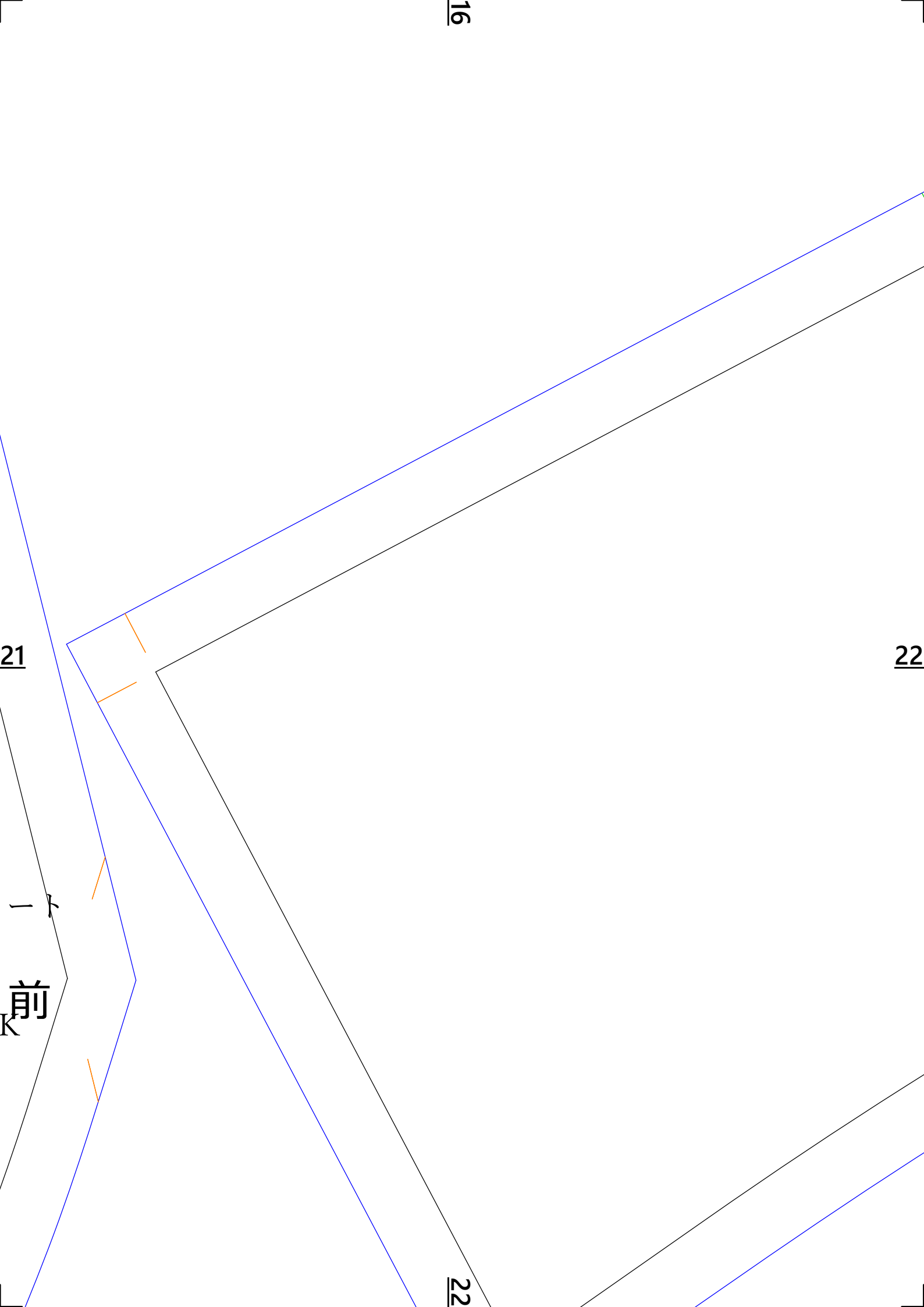

スタンドカラーコート  
裏前身頃  
裏地 x2  
PATTERN FLEEK

18

23

24

スタンドカラーコート  
見返し  
表地 x2  
芯地 x2  
PATTERN FLEEK



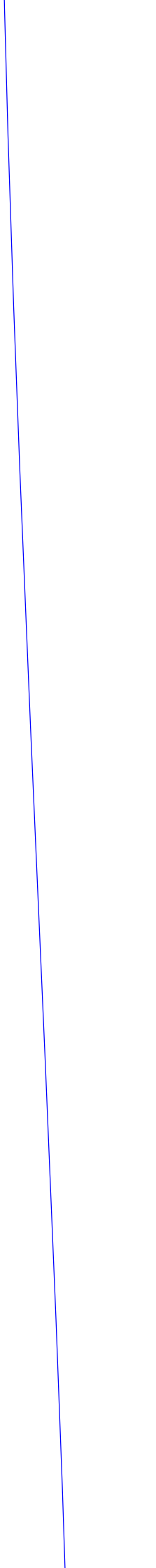

20

26

25

26

後

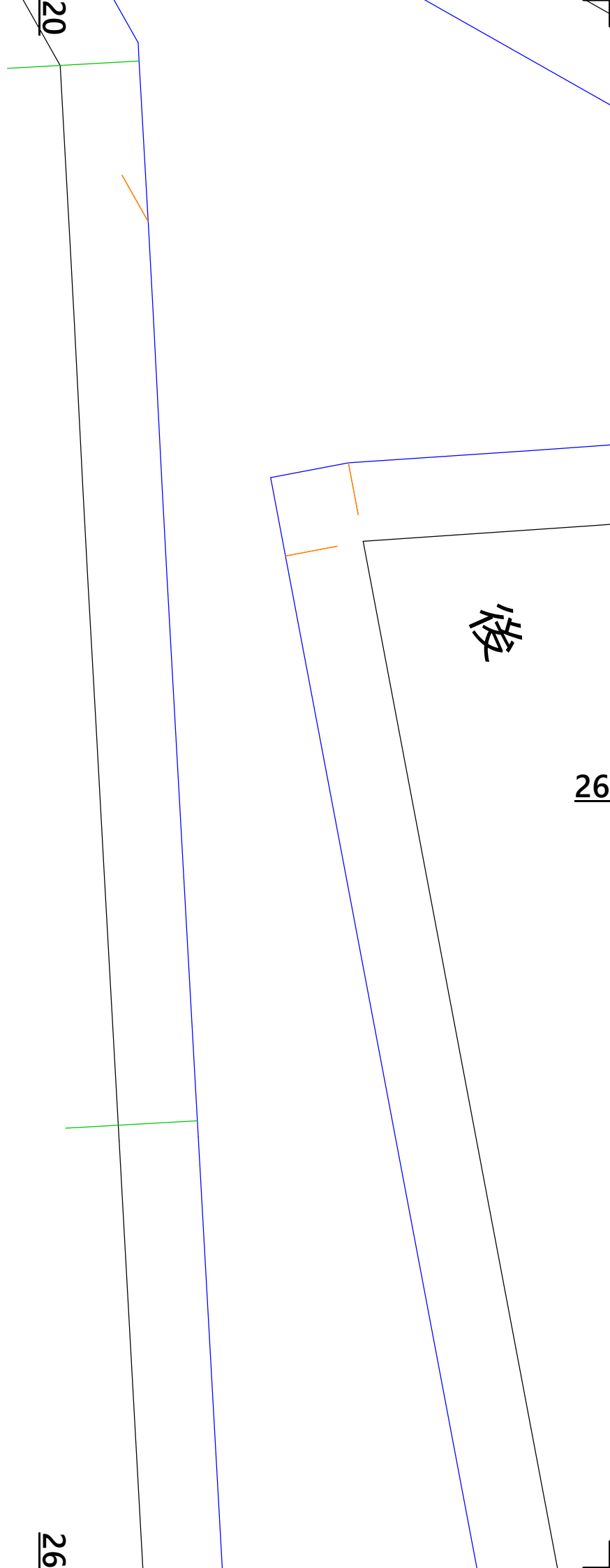

21

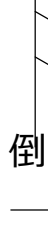
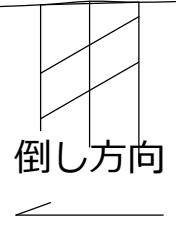
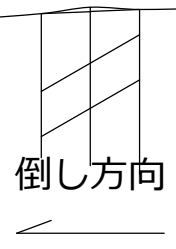
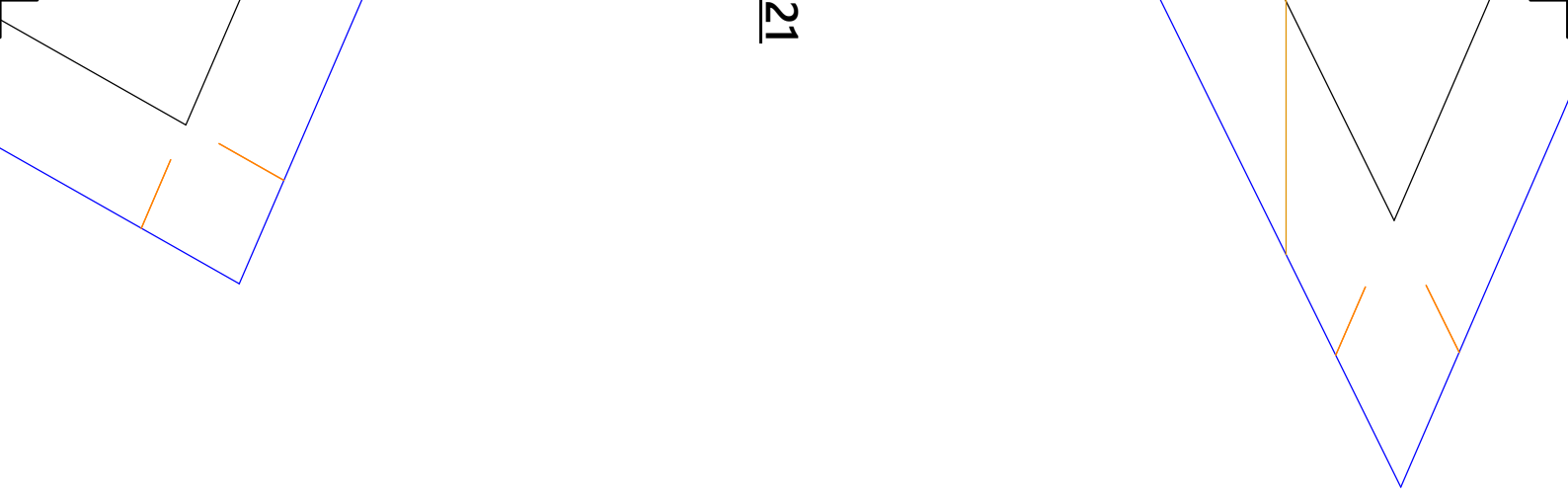

26

27

27裏裏P

22



27 タンドカラーコート

裏袖口

裏地 x2

PATTERN FLEEK

前

28

28

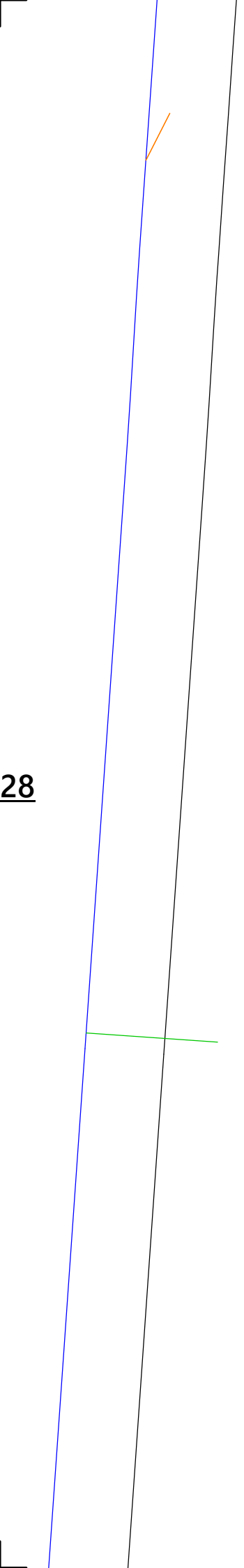

1

1



24

30



29

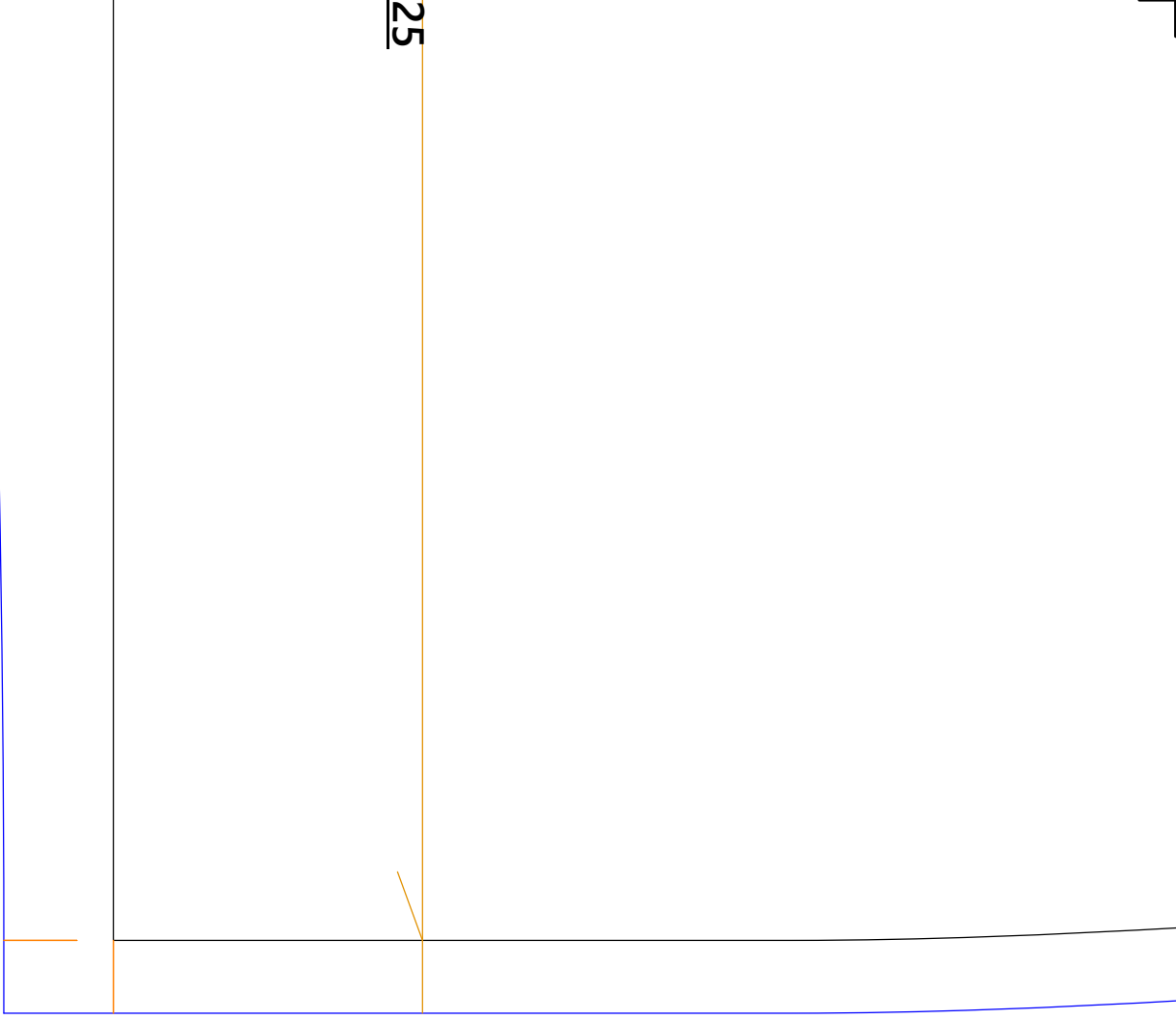

25

26

31

32

スタンドカラーコート  
ポケット口布  
表地 x2  
PATTERN FLEEK



スタンドカラーコート  
袋布B  
裏地 x2  
PATTERN FLEEK

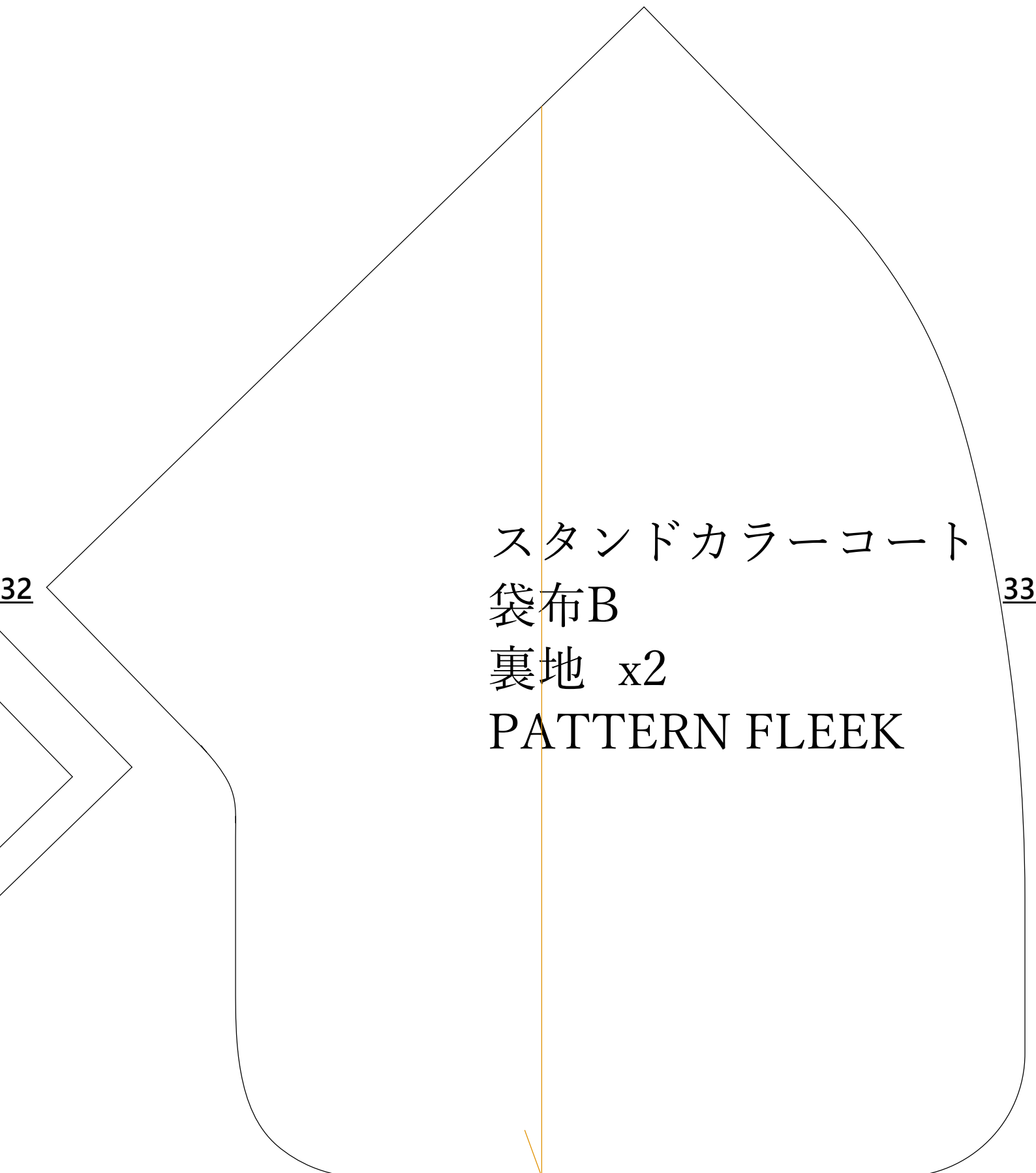

スタンドカラーコート  
袋布A  
裏地 x2  
PATTERN FLEEK

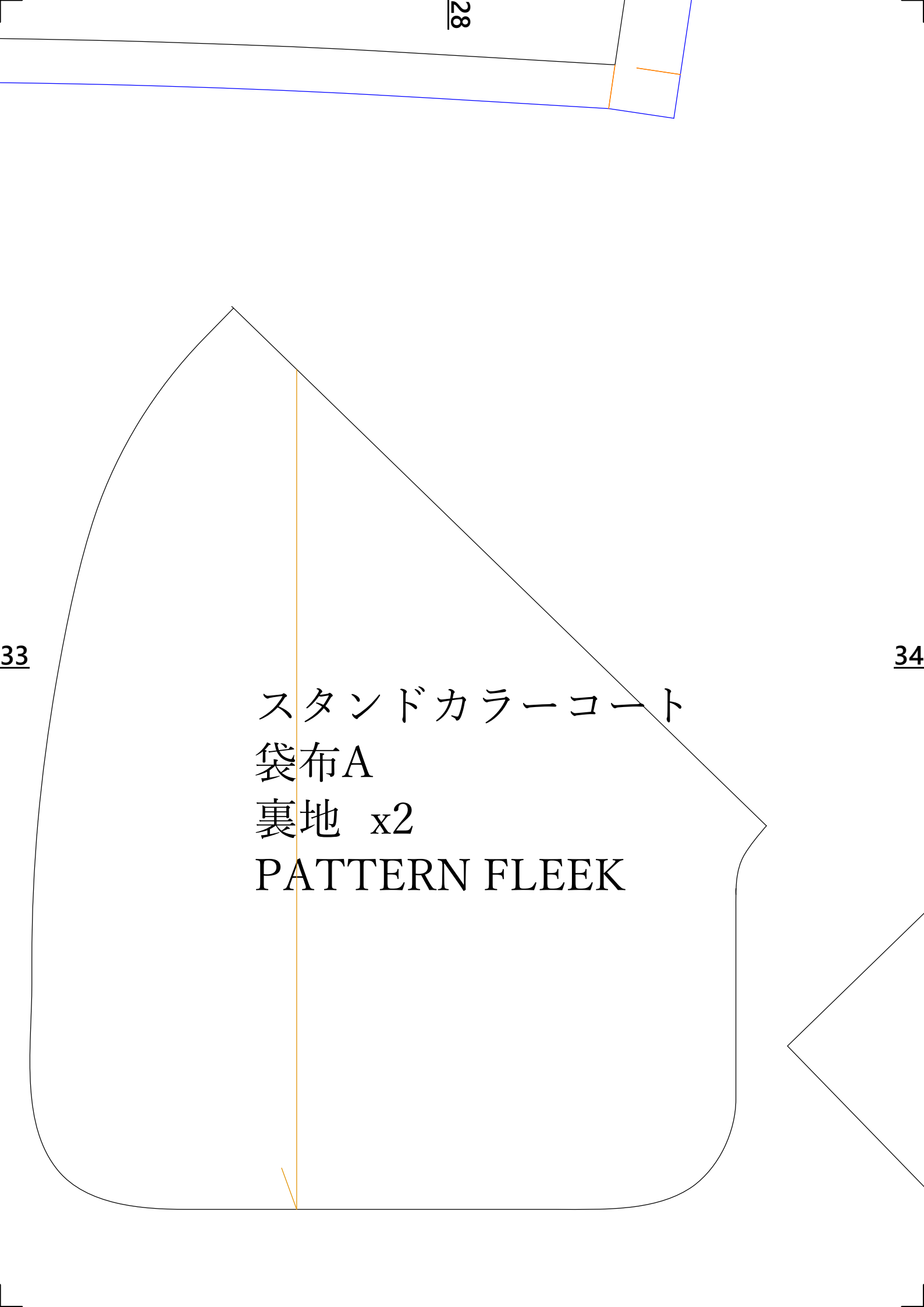

スタンドカラーコート  
 向こう布  
 表地 x2  
 PATTERN FLEEK

スタンドカラーコ  
 ポケット口芯  
 芯地 x2  
 PATTERN FLEEK

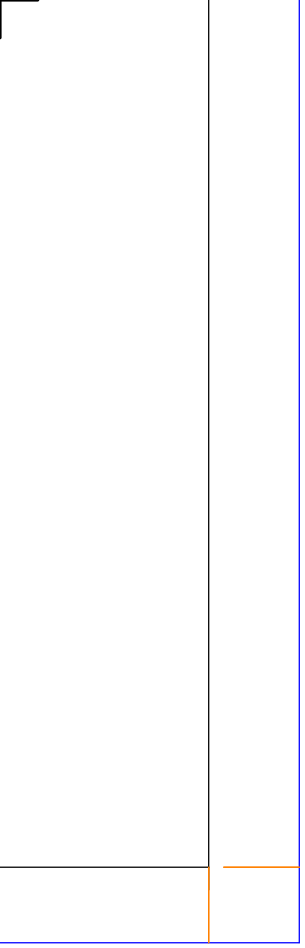

35

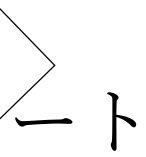

K

30

