

1

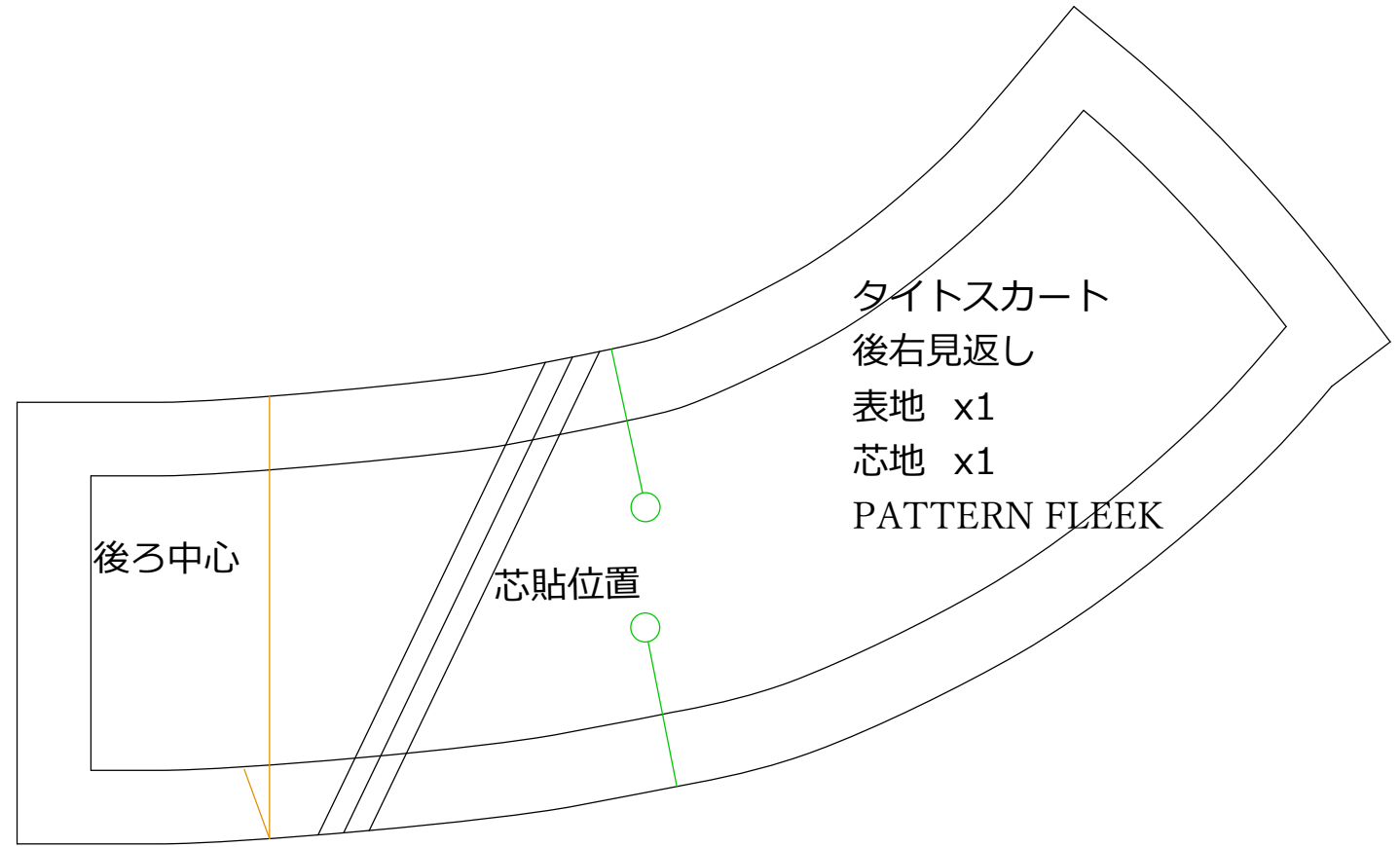

2

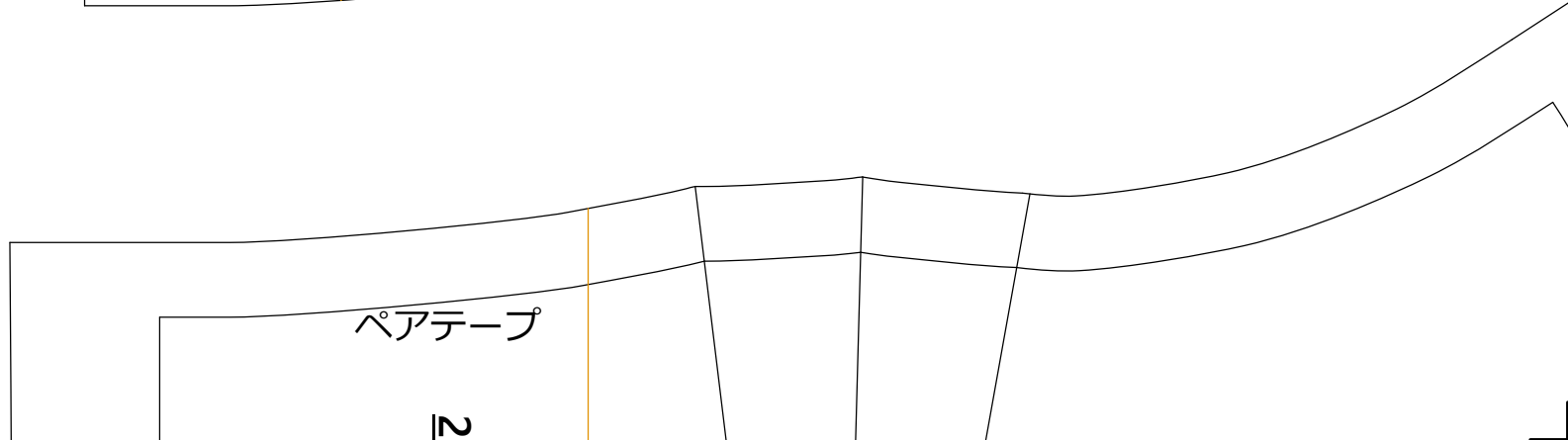

2

2

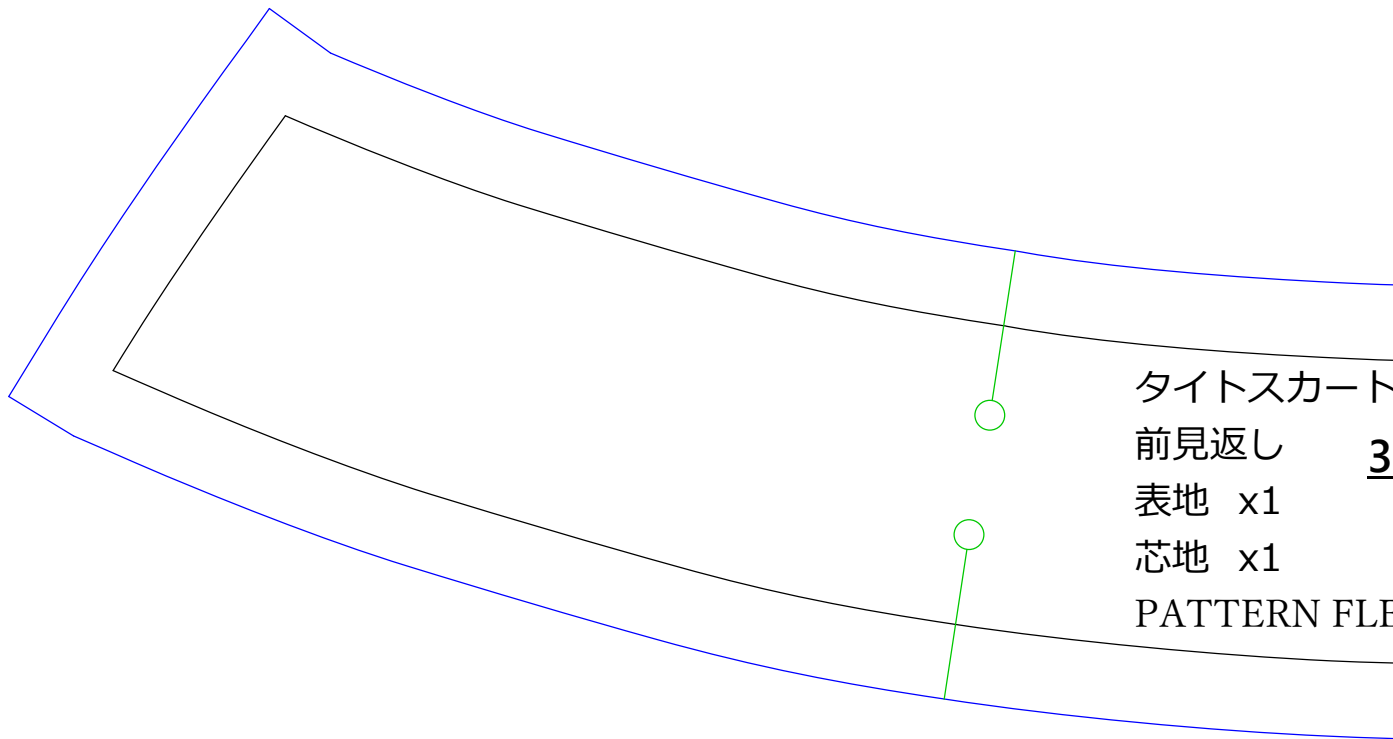

3

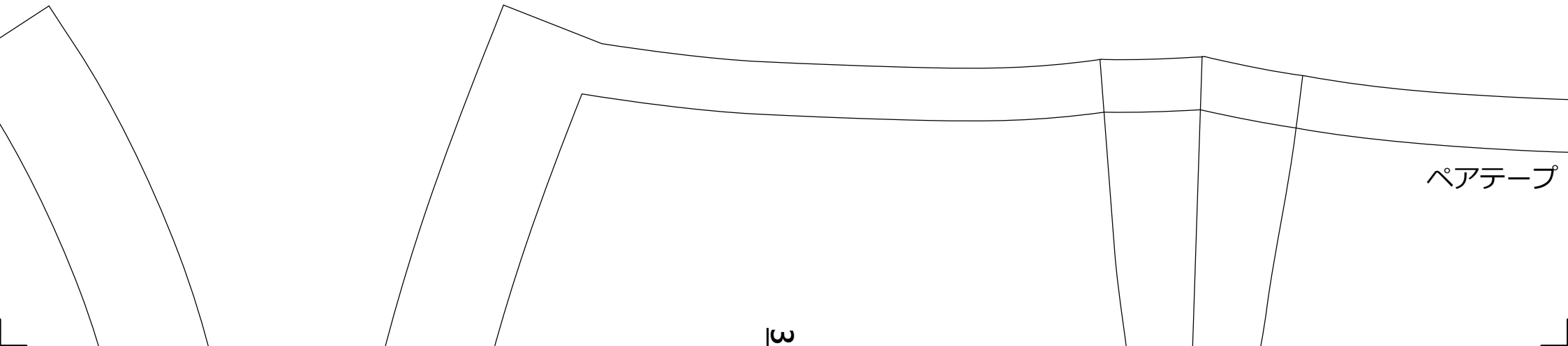

3

ペアテープ

3 前中心

EEK

芯貼位置

4

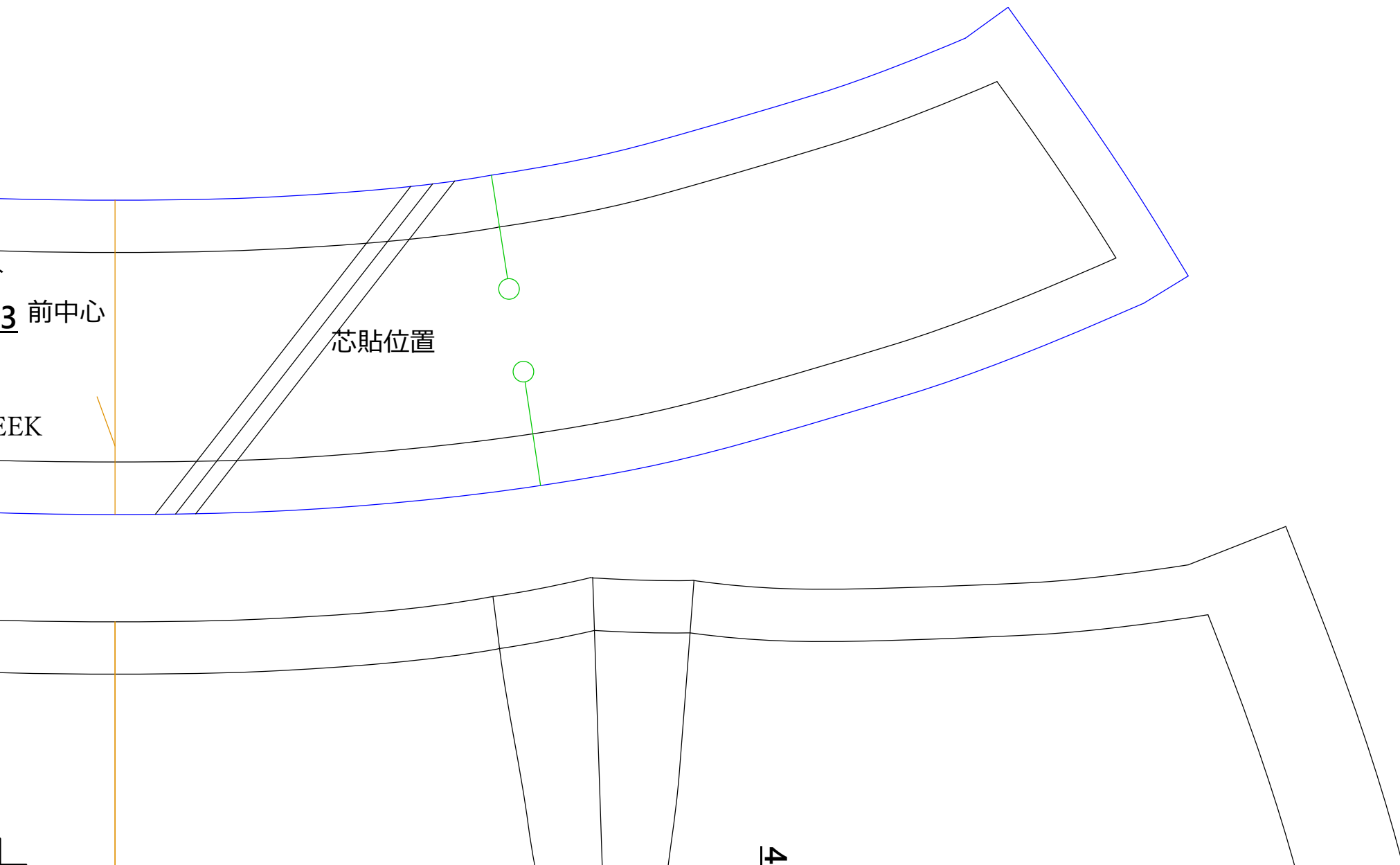

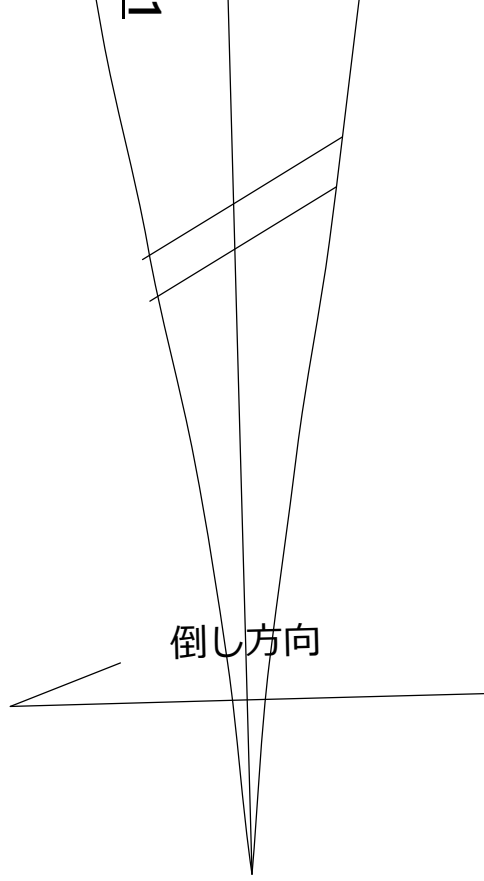
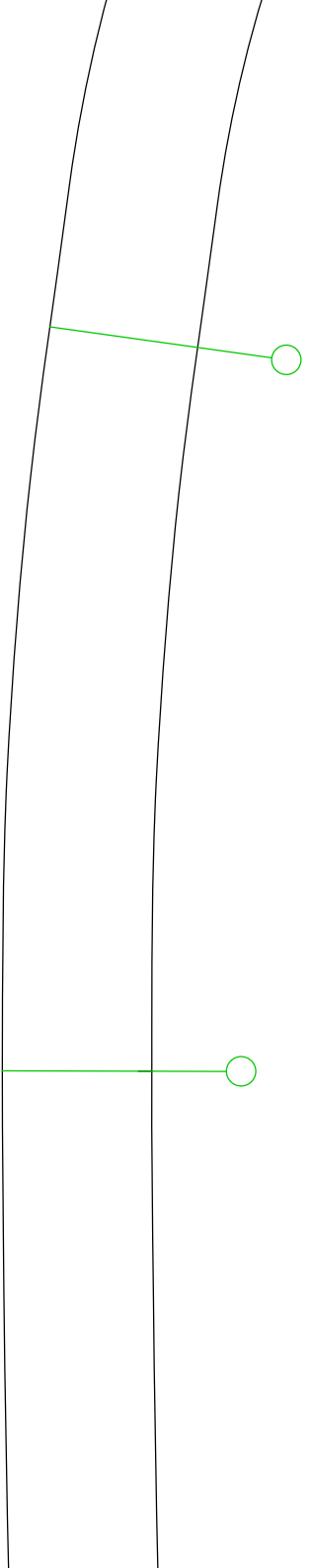

後ろ中心

ファスナー開き止まり



5

2

後ろ中心

ファスナー開き止まり

6

倒し方向

6

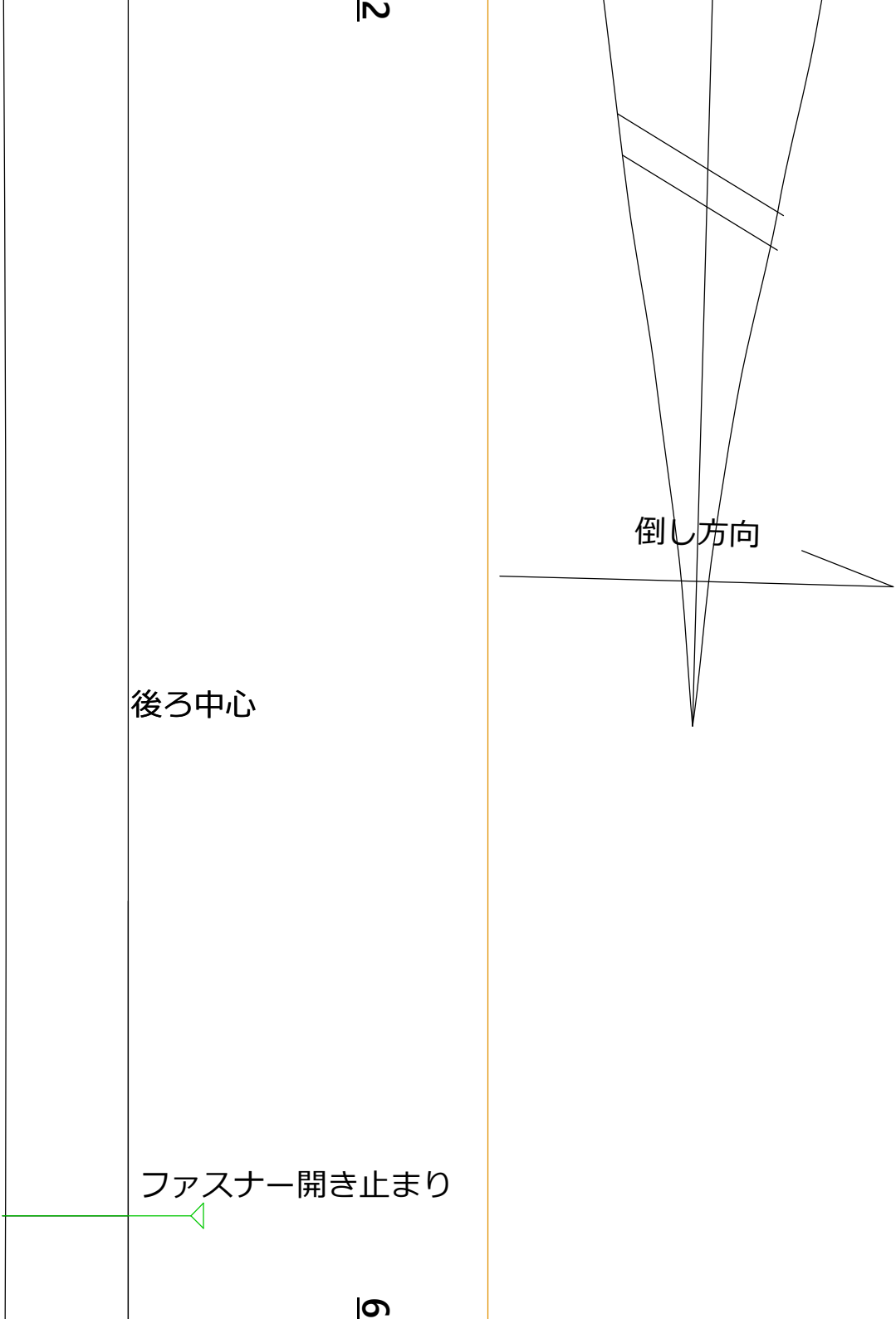

6

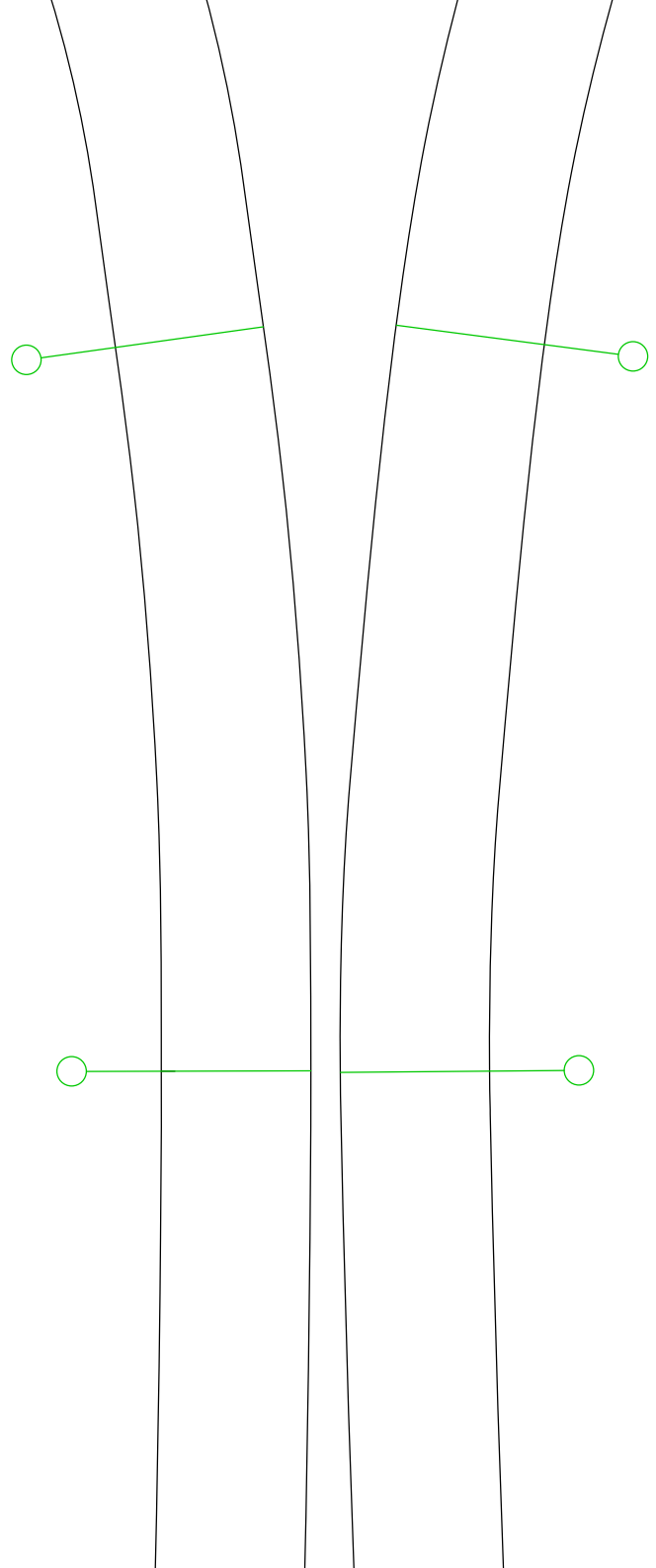

3

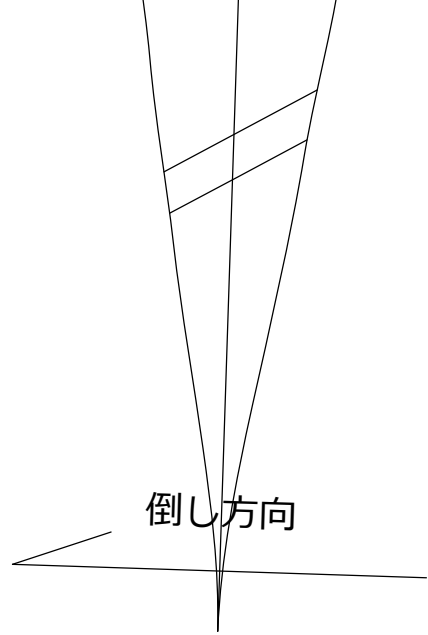

7

7

タイトスカート

7 前中心

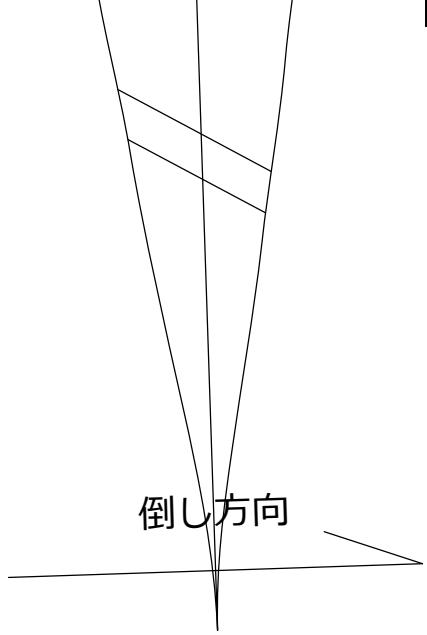

8

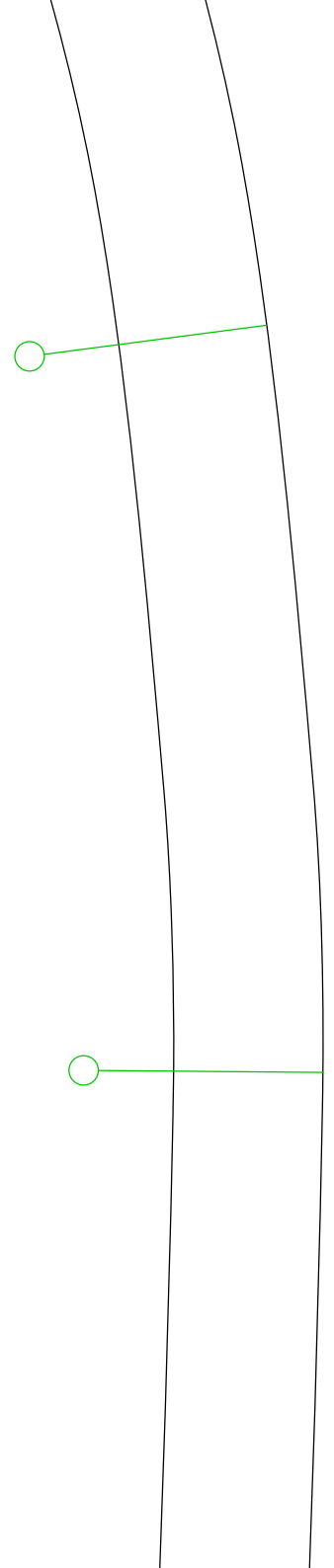

4

タイトスカート
左後スカート
表地 x1
PATTERN FLEEK

5

9

9

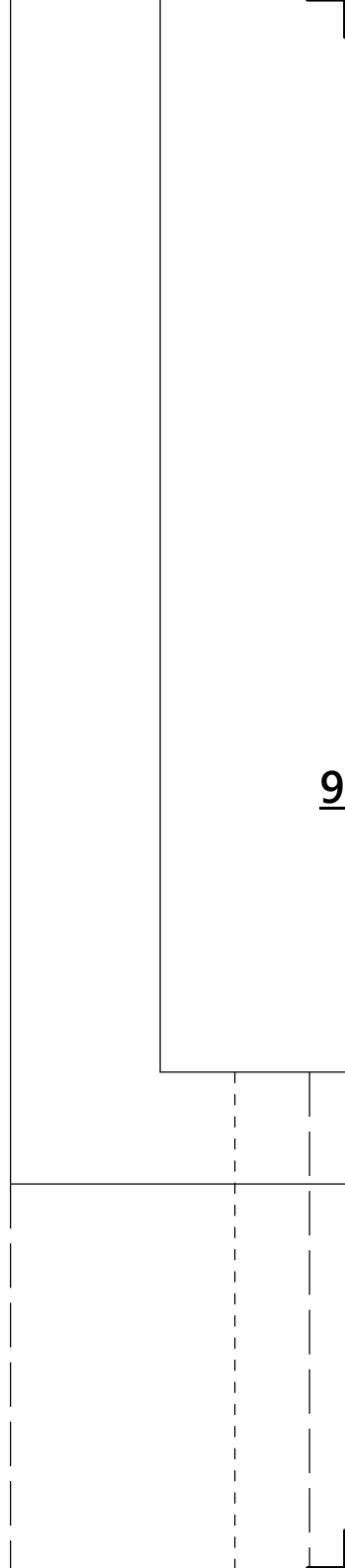

9

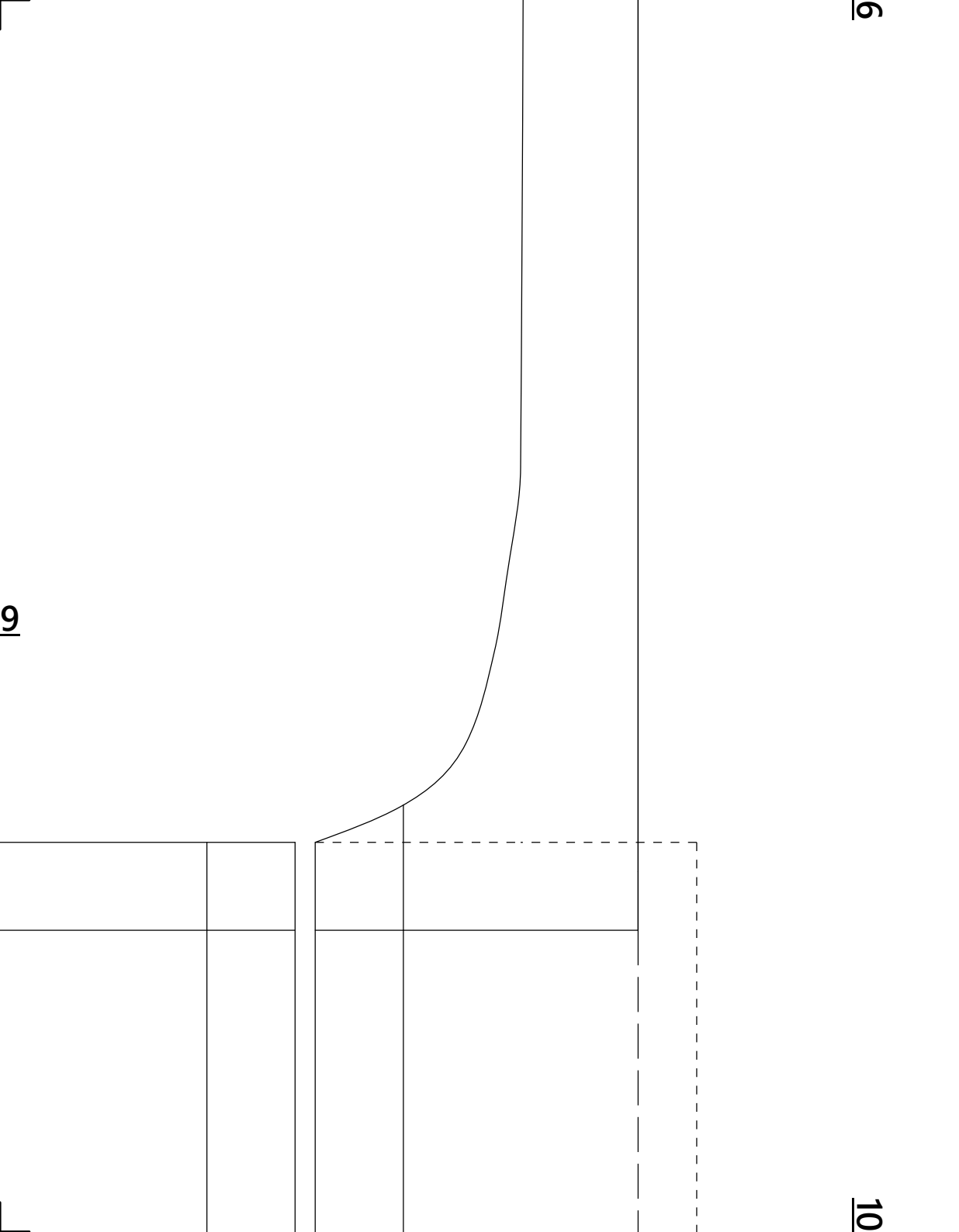

9

10

タイトスカート
右後スカート
表地 x1
PATTERN FLEEK

10

前スカート

表地 x1

PATTERN FLEEK

7

11

10

11





12

8

11

13

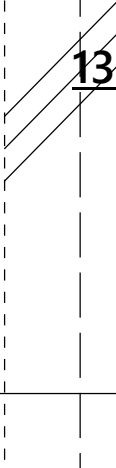

13

9

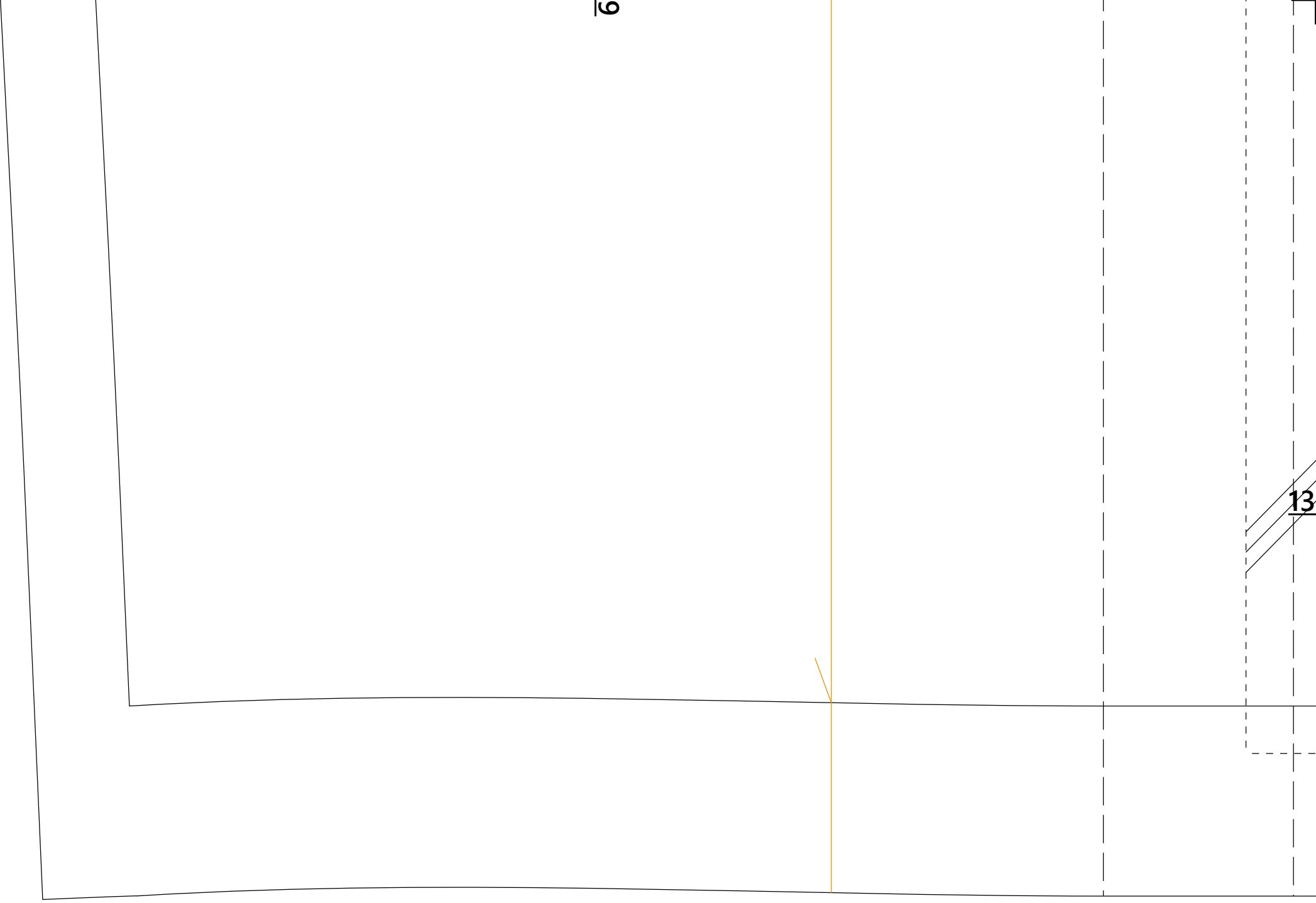

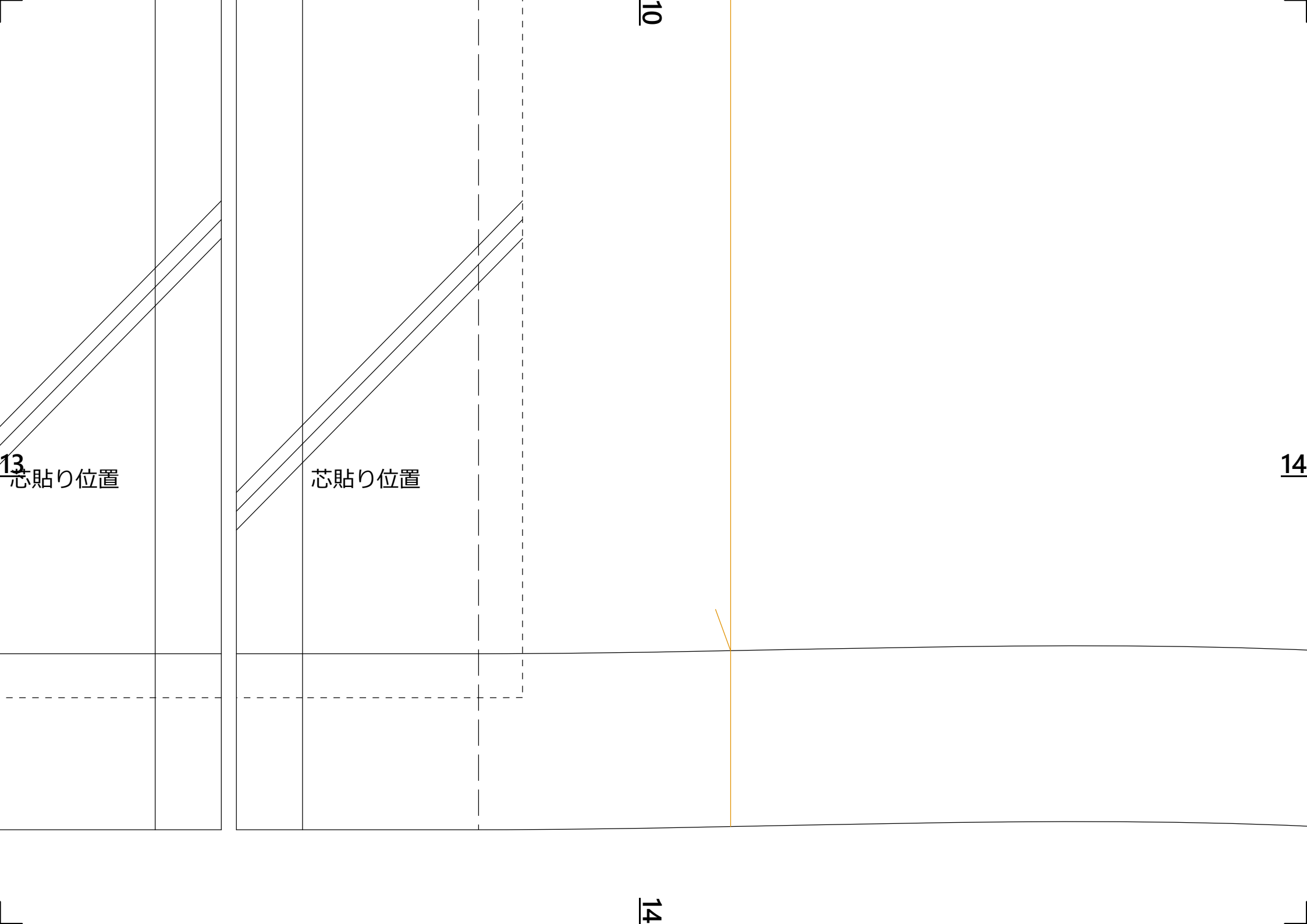

13
芯貼り位置

芯貼り位置

14

10

14

14

11

15

15

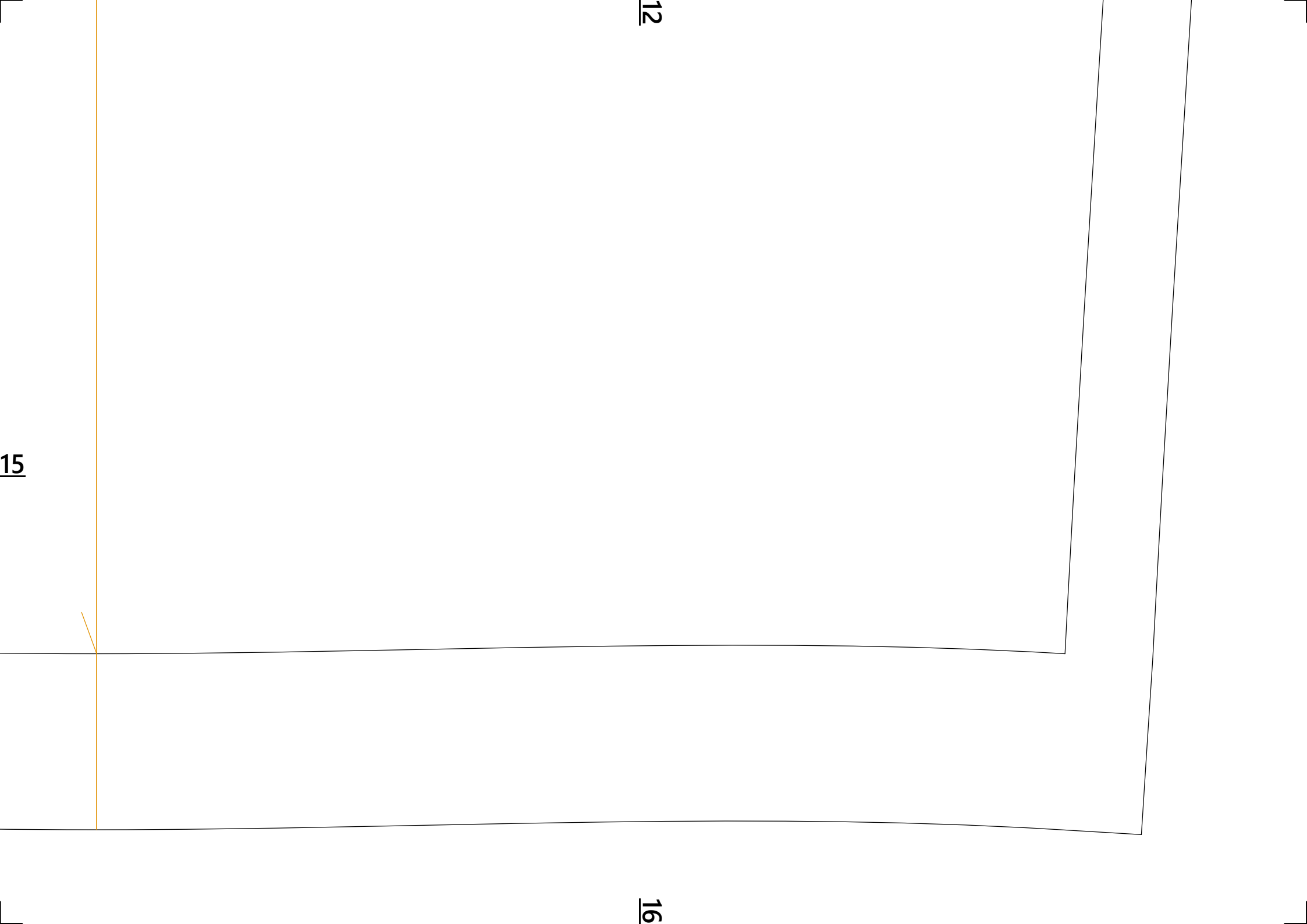

13

きせ0.3cm

きせ0.3cm

倒し方向

後ろ中心

17

17

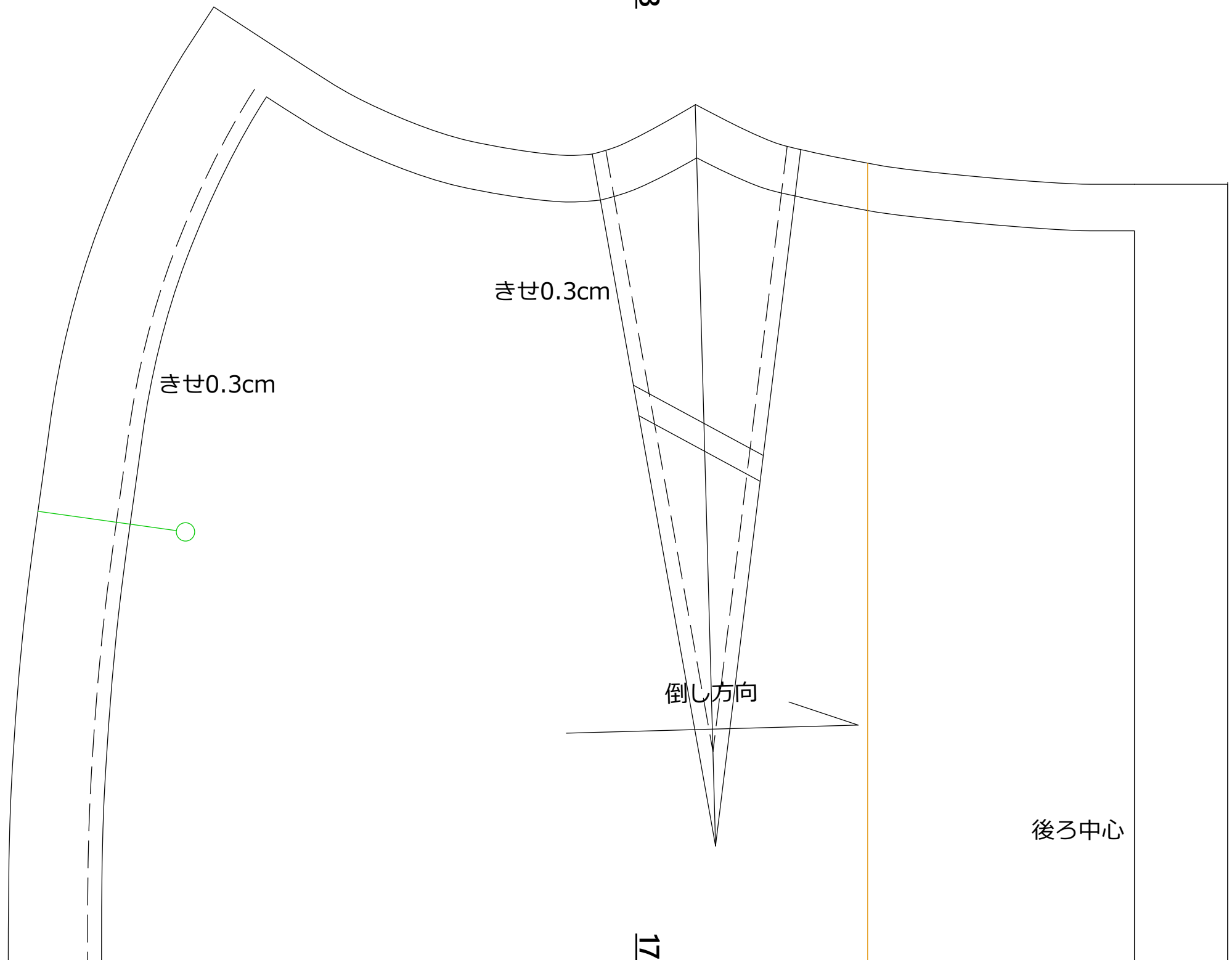

17

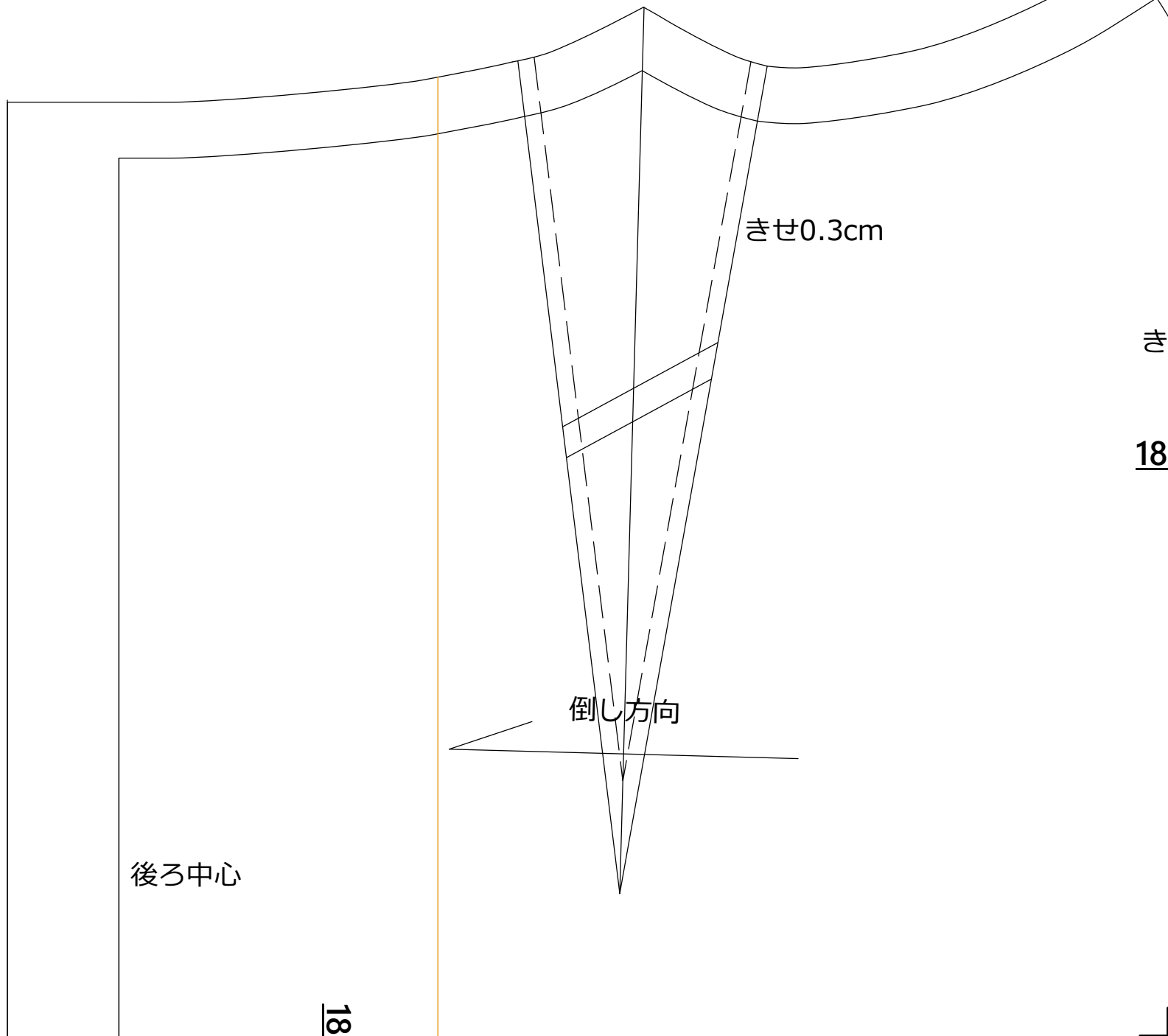

後ろ中心

倒し方向

きせ0.3cm

14

18

き

18

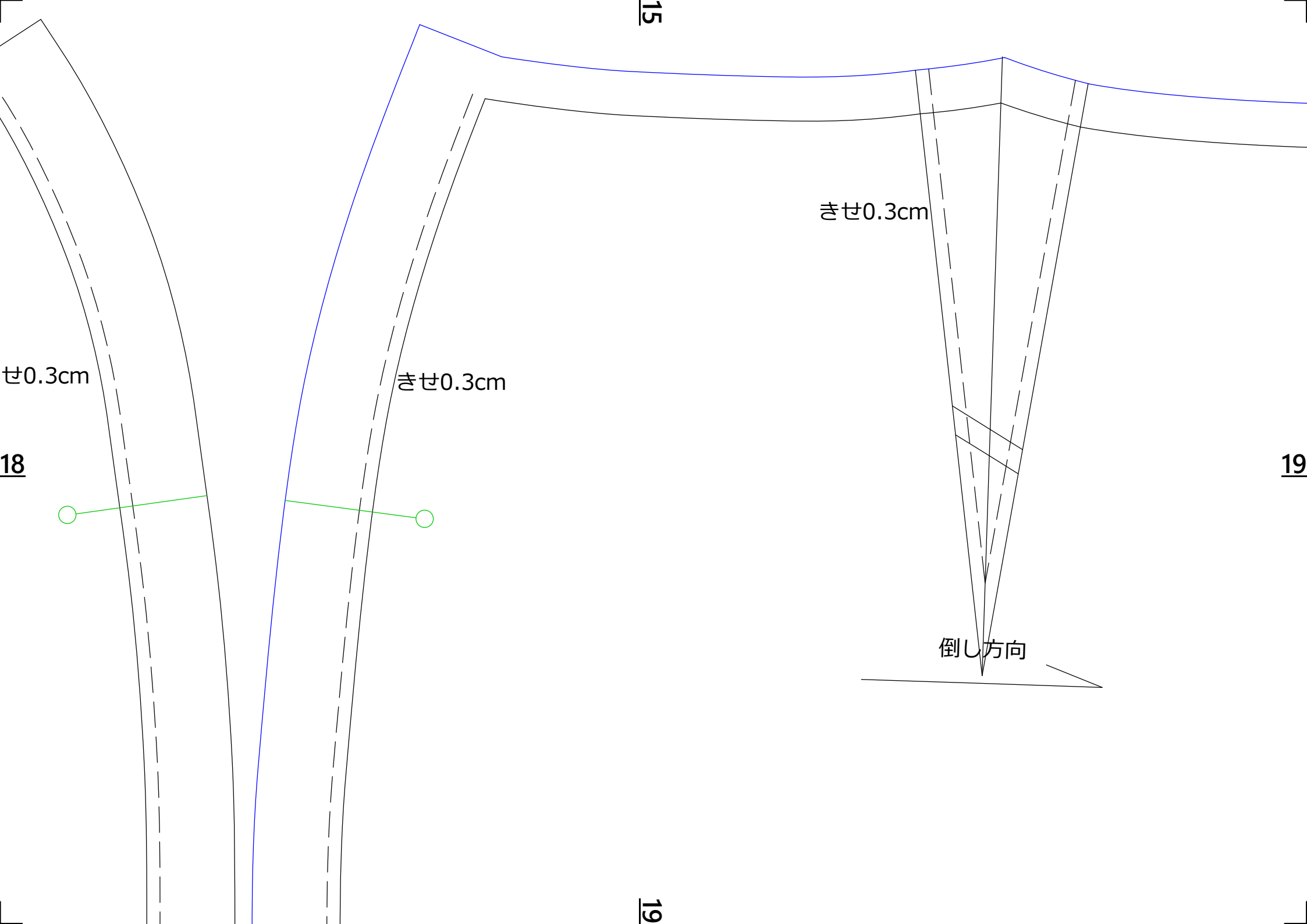

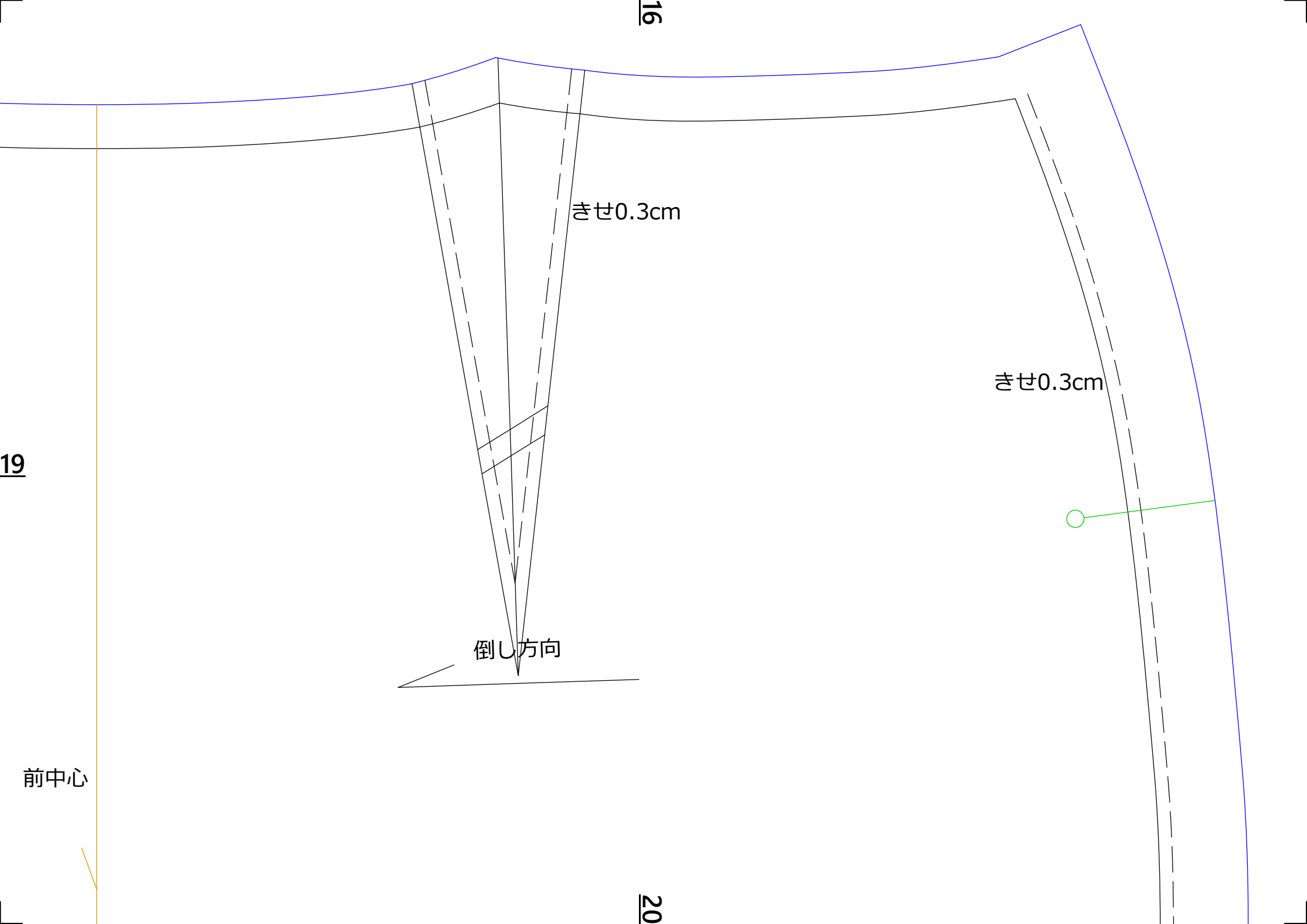

16

きせ0.3cm

きせ0.3cm

19

前中心

倒し方向

20

17

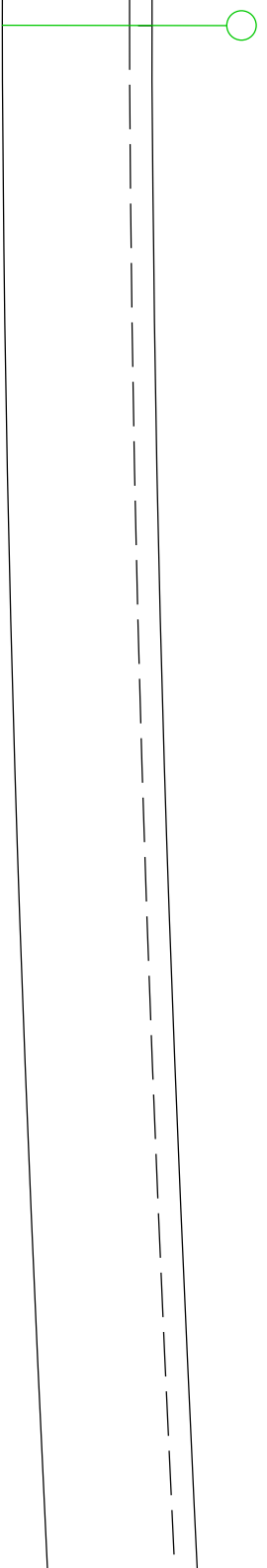

タイトスカート
右後スカート裏
裏地 x1
PATTERN FLEEK

21

縫い止まり



きせ0.3cm

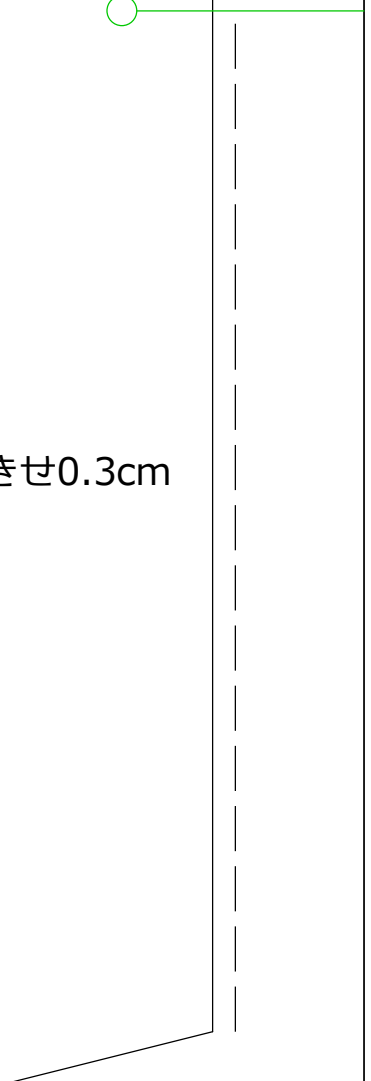

21

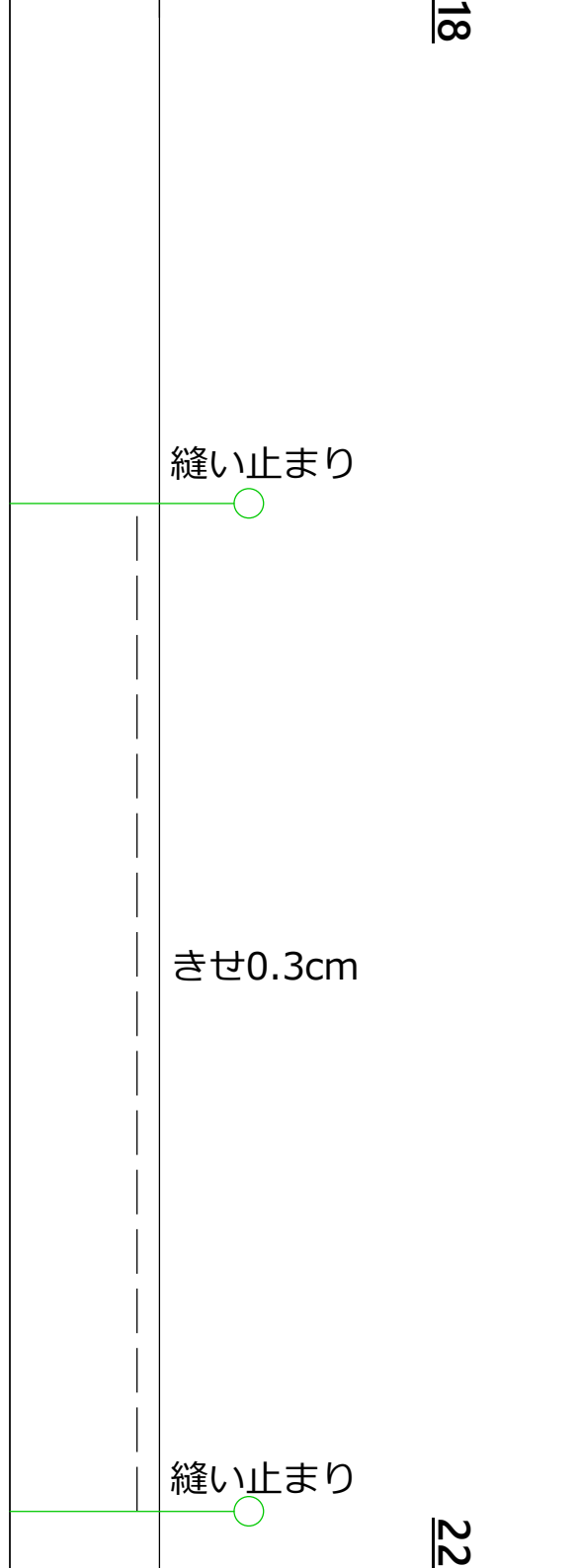

タイトスカート
左後スカート裏
裏地 x1
PATTERN FLEEK

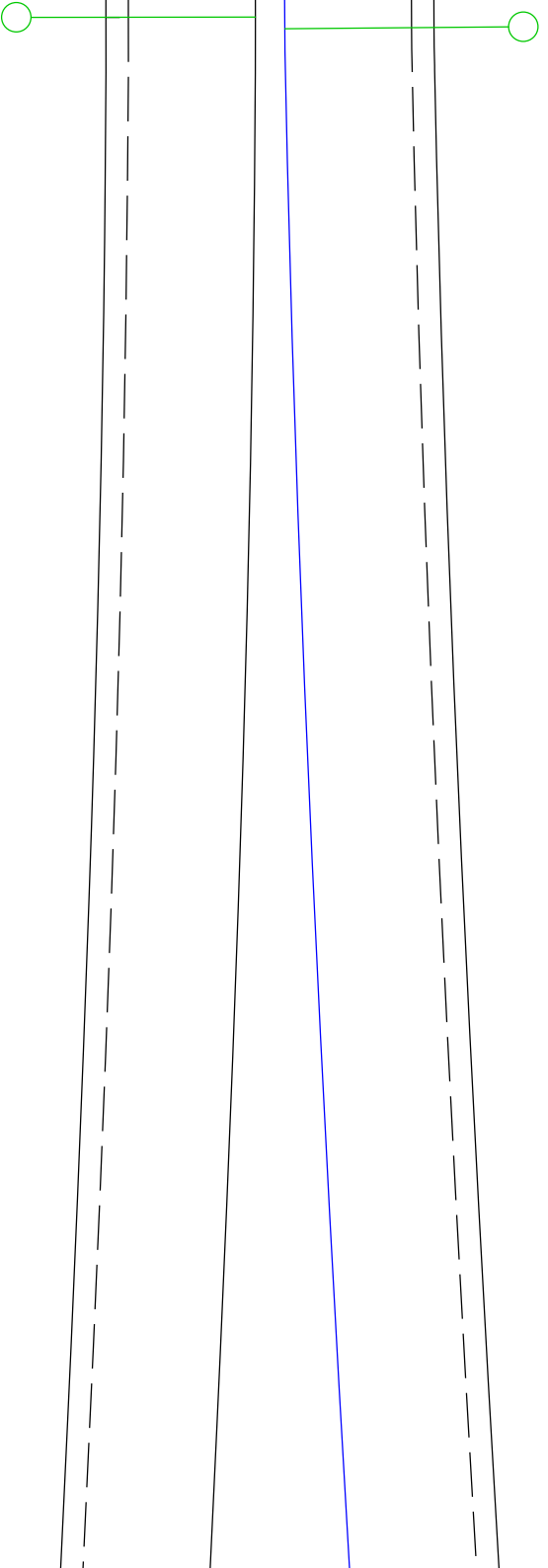

19

23

タイトスカート
前スカート裏
裏地 x1
PATTERN FLEEK

22

23

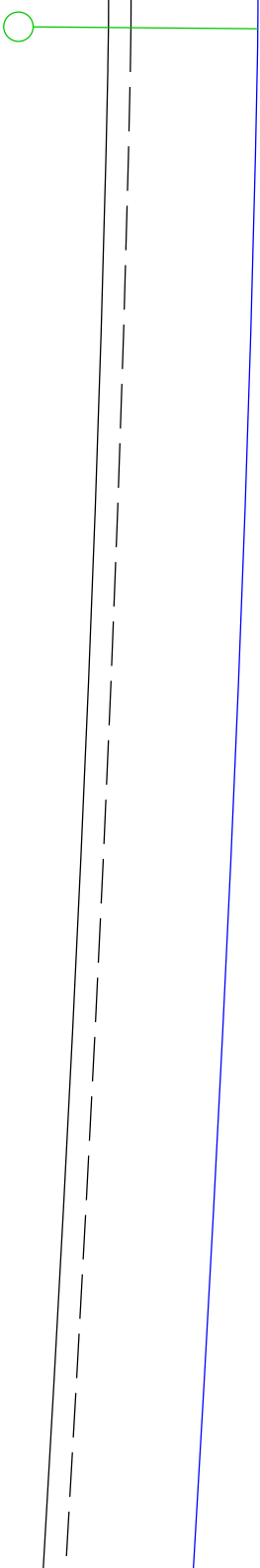

20

24

23

21

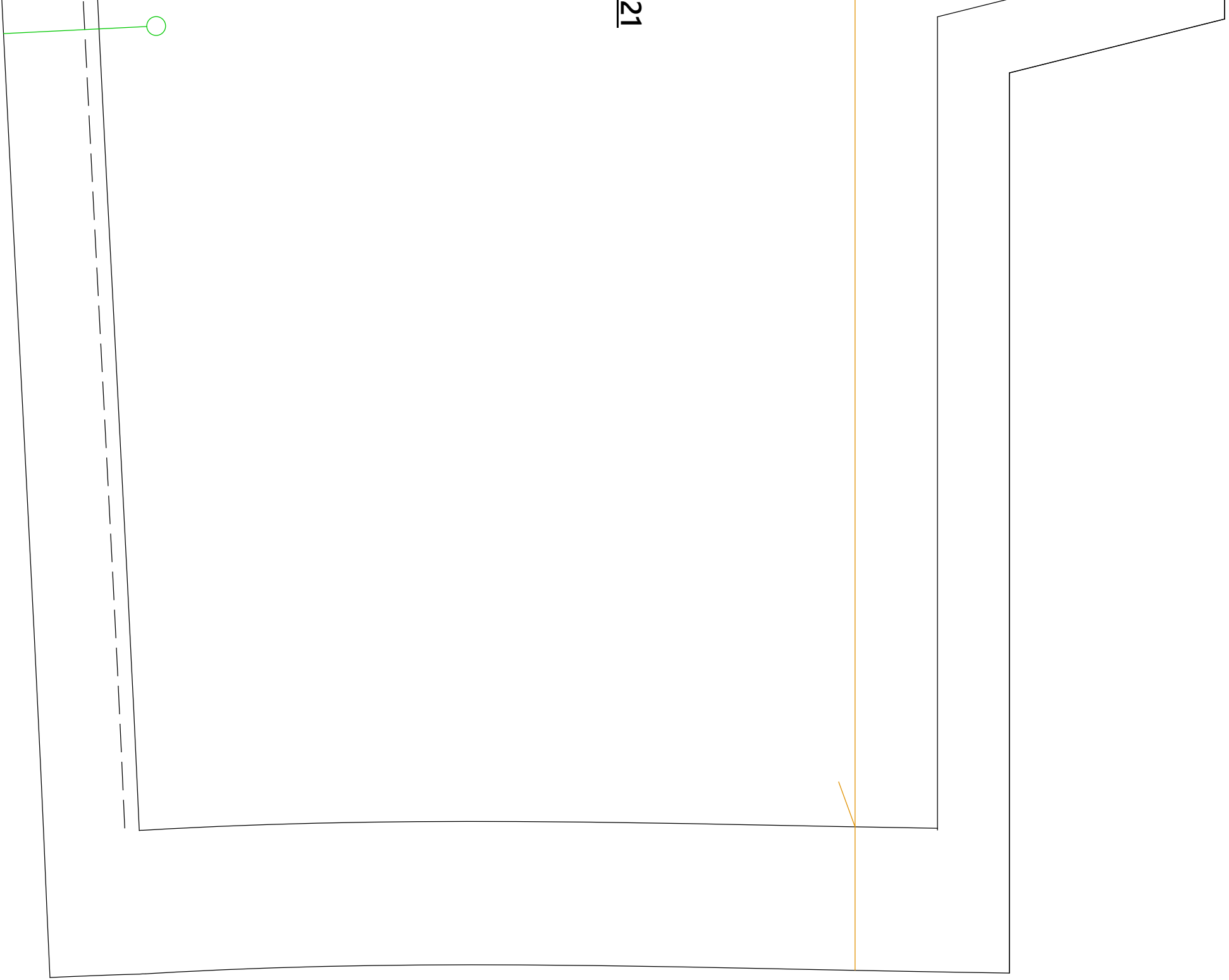

25

25

22

26

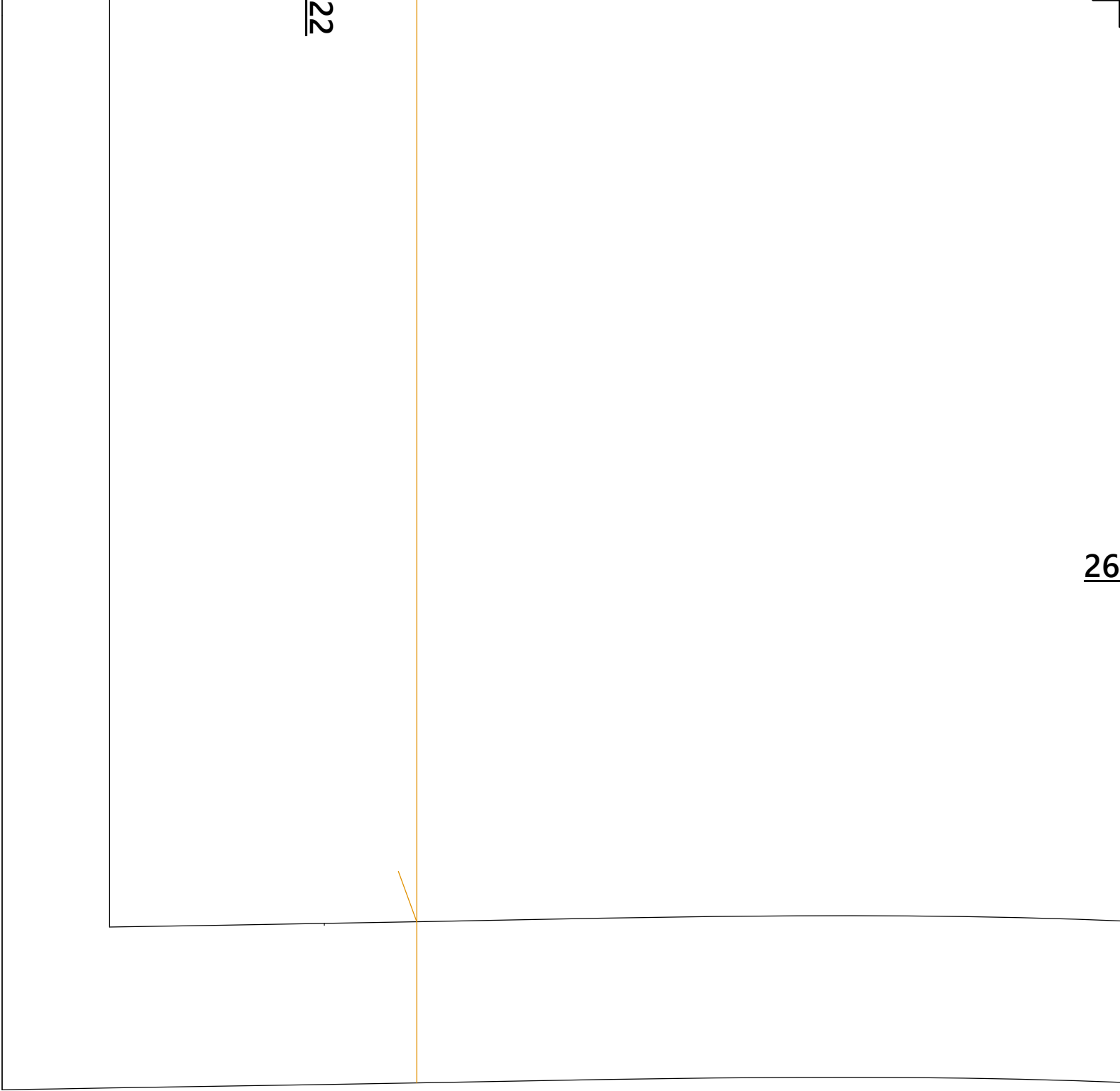

26

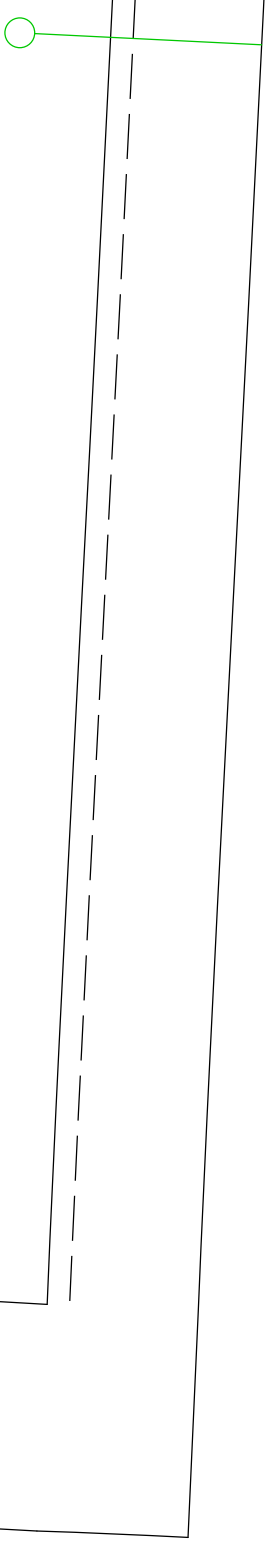

23

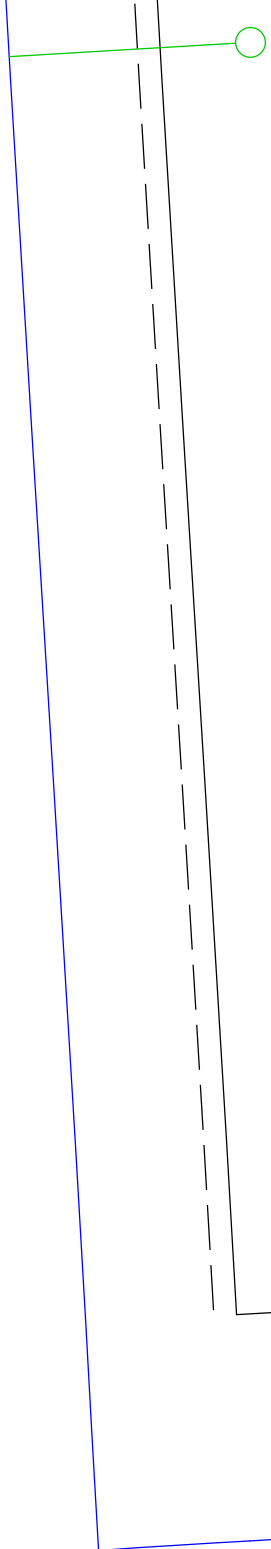

27

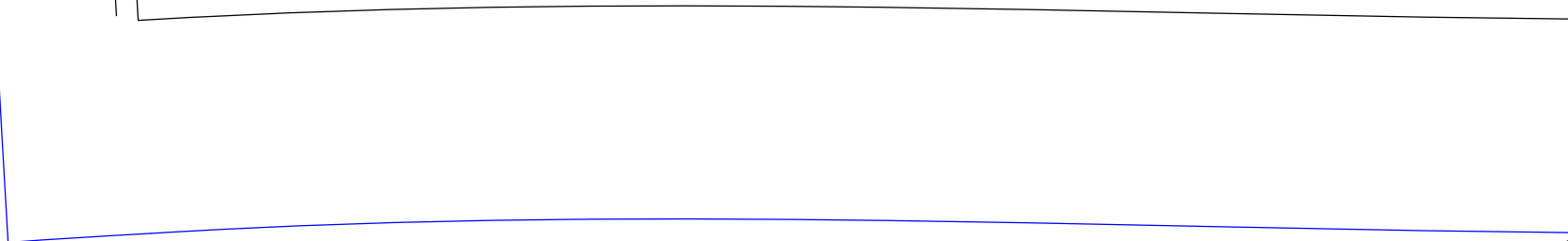



24

27

